



**SINCERELY COOPERATE WITH YOU IN FULL**



**Qingdao Magic Andy Hardware Co.,Ltd**

Add:Room 1601, Building 2 , No.63 Haier road, Qingdao, China  
Tel: +86 0532-80999628      Mobile: +86 13708996523  
E-mail: sales@cnmagicandy.com    manager@cnmagicandy.com  
Http://www.cnmagicandy.com



**Qingdao Magic Andy  
Hardware Co.,Ltd**

**SANITARY PRODUCT**



**Andy Tian**  
*General Manager*

Qingdao Magic Andy Hardware Co.,Ltd

Add: Room 1601, Building 2 , No.63 Haier road, Qingdao, China  
Tel: +86 0532-80999628      Mobile: +86 13708996523  
E-mail: sales@cnmagicandy.com    manager@cnmagicandy.com  
Http://www.cnmagicandy.com

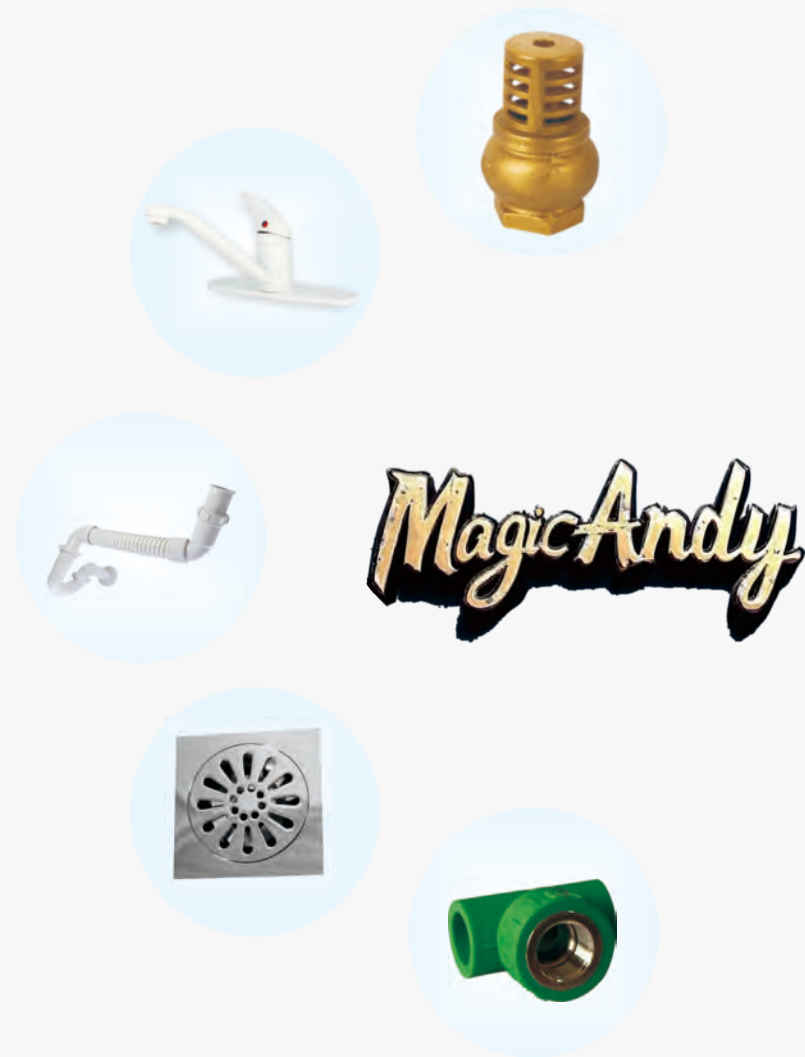

**Q**ingdao Magic Andy Hardware Co.,Ltd. specializes in producing sanitary products, such as valves, faucets, bibcocks, fittings and plumbing items. we also can designing according customers' inquiry.

During the course of development, we adhere to the marketing spirit of "Unity, industriousness, Exploration and innovation" to improve the quality of products and to perfect our series products.

With our reliable quality, competitive prices and first-rate services, our products gets high prestige in the world.

We sincerely wish to be joined by you for further development and bright future.

## CONTENTS

- ▶ *VALVE SERIAL* . . . . . 01--09
- ▶ *TAP & FAUCETS*. . . . . 10--25
- ▶ *SHOWER HEAD*. . . . . 26--27
- ▶ *FLOOR DRAIN* . . . . . 28
- ▶ *SANITARY HARDWARE*. . . . . 29
- ▶ *PLASTIC PLUMINGS*. . . . . 30--42
- ▶ *PLASTIC PIPE & FITTINGS*. . . . . 43-104
- ▶ *PVC VALVES* . . . . . 105-109
- ▶ *METAL TUBE & FITTINGS* . . . . . 110-128



# VALVE SERIES



**GDJD-1001** F/F  
1/2" 3/4" 1" 1 1/4" 1 1/2"  
2" 2 1/2" 3" 4"



**GDJD-1002** F/F  
1/2" 3/4" 1" 1 1/4" 1 1/2"  
2" 2 1/2" 3" 4"

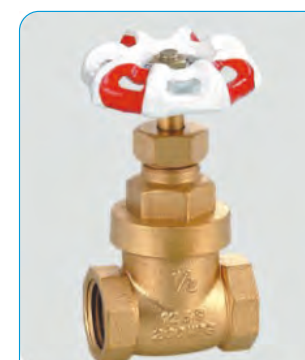

**GDJD-1003** F/F  
1/2" 3/4" 1" 1 1/4" 1 1/2"  
2" 2 1/2" 3" 4"

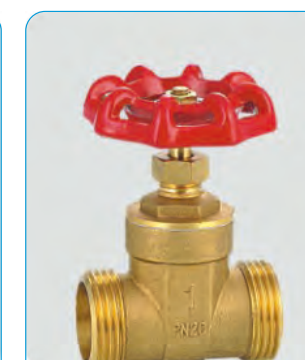

**GDJD-1004** M/M  
1/2" 3/4" 1"



**GDJD-1005** F/F  
1/2" 3/4" 1" 1 1/4" 1 1/2"  
2" 2 1/2" 3" 4"



**GDJD-1006** F/F  
1/2" 3/4" 1" 1 1/4" 1 1/2"  
2" 2 1/2" 3" 4"



**GDJD-1007** F/F  
1/2" 3/4" 1" 1 1/4" 1 1/2"  
2" 2 1/2" 3" 4"



**GDJD-1008** F/F  
1/2" 3/4" 1" 1 1/4" 1 1/2"  
2"

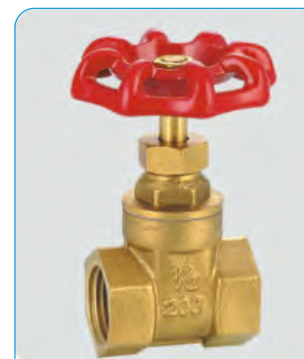

**GDJD-1009** F/F  
1/2" 3/4" 1" 1 1/4" 1 1/2"  
2" 2 1/2" 3" 4"



**GDJD-1010 SOLDER**  
1/2" 3/4" 1" 1 1/4" 1 1/2"  
2" 2 1/2" 3" 4"



**GDJD-1011** F/F  
1/2" 3/4" 1" 1 1/4" 1 1/2"  
2" 2 1/2" 3" 4"

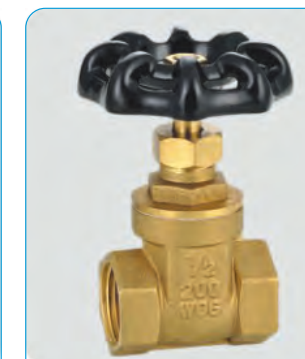

**GDJD-1012** F/F  
1/2" 3/4" 1" 1 1/4" 1 1/2"  
2" 2 1/2" 3" 4"



**GDJD-1013** C/C  
1/2" 3/4" 1" 1 1/4" 1 1/2"  
2" 2 1/2" 3" 4"



**GDJD-1014** C/C  
1/2" 3/4" 1" 1 1/4" 1 1/2"  
2" 2 1/2" 3" 4"



**GDJD-1015** F/F  
1/2" 3/4" 1" 1 1/4" 1 1/2"  
2" 2 1/2" 3" 4"



**GDJD-1016** M/M  
1/2" 3/4" 1" 1 1/4" 1 1/2"  
2" 2 1/2" 3" 4"



**GDJD-4001**  
1/2" 3/4" 1" 1-1/4" .....4"



**GDJD-4002**  
1/2"



**GDJD-4003**  
1/2"



**GDJD-4016**  
1/2"



**GDJD-4017**  
1/2" 3/4" 1" 1-1/4" .....4"



**GDJD-4018**  
1/2" 3/4" 1" 1-1/4" 1-1/2" 2"



**GDJD-4004**  
1/2" 3/4" 1" 1-1/4" .....4"



**GDJD-4005**  
1/2" 3/4" 1" 1-1/4" 1-1/2" 2"



**GDJD-4006**  
1/2" 3/4" 1" 1-1/4" .....4"



**GDJD-4019**  
1/2" 3/4" 1" 1-1/4" .....4"



**GDJD-4020**  
1/2" 3/4" 1" 1-1/4" 1-1/2" 2"



**GDJD-4021**  
1/2" 3/4" 1" 1-1/4" 1-1/2" 2"



**GDJD-4007**  
1/2" 3/4" 1" 1-1/4" .....4"



**GDJD-4008**  
1/2" 3/4" 1" 1-1/4" 1-1/2"



**GDJD-4009**  
1/2" 3/4" 1" 1-1/4" 1-1/2" 2"



**GDJD-4022**  
1/2" 3/4" 1" 1-1/4" .....4"



**GDJD-4024**  
1/2" 3/4" 1"

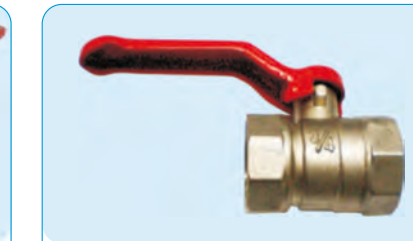

**GDJD-ITALALY**  
1/2" 3/4" 1" 1 1/4" 1 1/2" 2"



**GDJD-4010**  
1/2" 3/4" 1" 1-1/4" .....4"



**GDJD-4011**  
1/2" 3/4" 1" 1-1/4" 1-1/2" 2"



**GDJD-4012**  
1/2" 3/4" 1" 1-1/4" 1-1/2" 2"



**GDJD-4025**  
1/2" 3/4" 1"



**GDJD-4026**  
1/2" 3/4" 1"

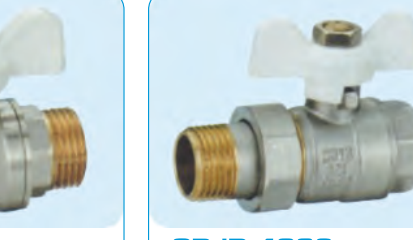

**GDJD-4028**  
1/2" 3/4" 1"



**GDJD-4013**  
1/2" 3/4" 1" 1-1/4" 1-1/2" 2"



**GDJD-4014**  
1/2" 3/4" 1" 1-1/4" 1-1/2" 2"



**GDJD-4015**  
1/2" 3/4" 1" 1-1/4" 1-1/2" 2"



**GDJD-4030**  
1/2" 3/4" 1" 1 1/4" 1 1/2" 2"



**GDJD-4031**  
1/2" 3/4"

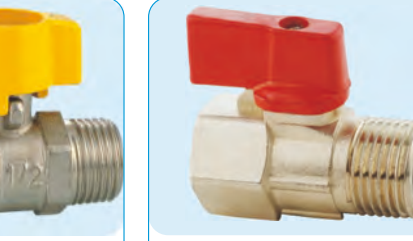

**GDJD-4032**  
1/2" 3/4"



**GDYF-030**  
1/2" 3/4"



**GDJD-3001**

1/2" 3/4" 1" 1 1/4" 1 1/2" 2"



**GDJD-3002**

1/2" 3/4" 1" 1-1/4" .....4"



**GDJD-3003**

1/2" 3/4" 1" 1-1/4" .....4"



**GDJD-3004**

1/2" 3/4" 1" 1-1/4" .....4"

s.s. filter



**GDJD-3006**

1/2" 3/4" 1" 1-1/4" .....4"



**GDJD-3007**

1/2" 3/4" 1" 1-1/4" .....4"

Y filter female



**GDJD-3009**

1/2"

stop valve



**GDJD-3010**

1/2" 3/4"

ferrule valve



**GDJD-3011**

1/2" 3/4"

stop valve



**GDJD-3012**

1/2" 3/4" 1"

stop valve



**GDJD-3013**

1/2" 3/4" 1"

stop valve



**GDJD-3014**

stop valve



**GDJD-3008**

1/2" 3/4" 1"

stop valve



**GDJD-3015**

1/2"

stop valve



**GDJD-3017**

1/2" 3/4" 1" 1 1/4" 1 1/2" 2"

stop valve



**GDJD-3018**

1/2" 3/4" 1"

stop valve



**GDJL-9001**



**GDJL-9002**



**GDJL-9003**



**GDJL-9004**



**GDJL-9005**



**GDJL-9006**



**GDJL-9007**



**GDJL-9008**



**GDJL-9009**



**GDJL-9010**



**GDJL-9012**



**GDYF028E**



**GDJL-8101**



**GDJL-8102**



**GDJL-8103**



**GDJL-8103**



**GDJL-8105**



**GDJD-5001**  
1/2x1/2"



**GDJD-5002**  
1/2x1/2"



**GDJD-5003**  
1/2x1/2"



**GDJD-5004**  
1/2x1/2"



**GDJD-5005**  
1/2x1/2"



**GDJD-5006**  
1/2x1/2"



**GDJD-5007**  
1/2x1/2"



**GDJD-5008**  
1/2x1/2"



**GDJD-5009**  
1/2x1/2"



**GDJD-5010**  
1/2x1/2"



**GDJD-5011**  
1/2x1/2"



**GDJD-5012**  
1/2x3/4"



**GDJD-5013**  
1/2x1/2"



**GDJD-5014**  
1/2x3/4"



**GDJD-5015**  
1/2x3/8"



**GDJD-5016**  
1/2x3/8"



**GDJL-9108**



**GDJL-9110**



**GDJL-9111**



**GDYF033**



**GDYF007**



**GDYF010**



**GDYF011**



**GDYF012**



**GDYF015**



**GDYF018**



**GDYF020**



**GDYF026**



**GDJD-5017**  
1/2"



**GDJD-5018**  
1/2"



**GDJD-5019**  
1/2"



**GDJD-5020**  
1/2"



**GDJD-5021**



**GDJD-5022**



**GDJD-5023**  
1/2"



**GDJD-5024**  
1/2"



**GDJD-3019**  
1/2" 3/4"



**GDJD-3020**  
1/2" 3/4"



**GDJD-3021**  
1/2" 3/4"



**GDJD-3022**  
1/2"



**GDJD-3005**  
1/2" 3/4" 1" 1-1/4" .....4"

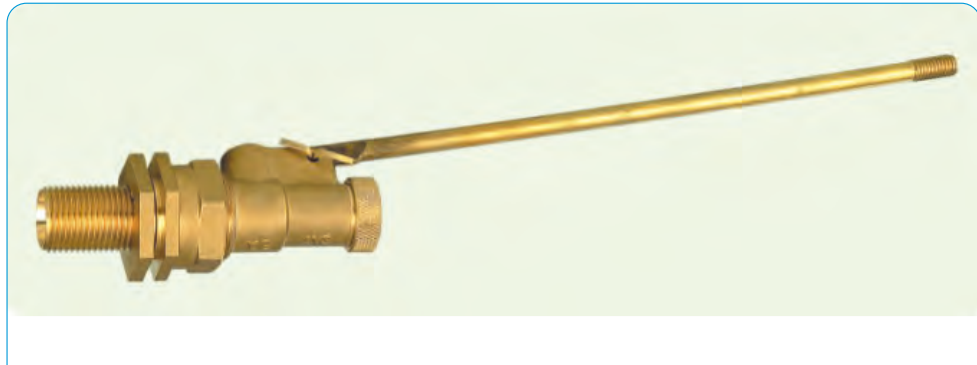

**GDJD-3023**  
1/2"



**GDJD-3025**  
1/2" 3/4" 1" 1 1/4" 1 1/2" 2"

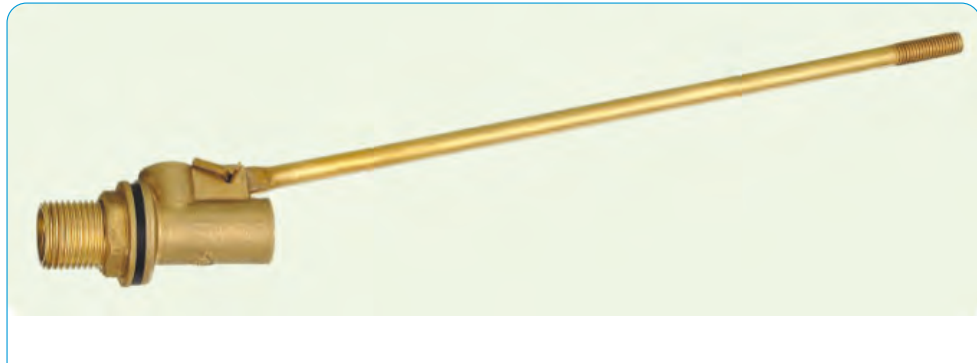

**GDJD-3024**  
1/2" 3/4" 1"



**GD-H2002**  
DIN3352-F5  
GATE VALVE (NRS)



**GD-H2004**  
ANSI Y-TYPE  
STRAINER



**GD-H2003**  
ANSI CHECK VALVE  
1.5~16" DN40~160MM

## TAP SERIES





GDJD-2988



GDJD-6082



GDJD-2387



GDJD-2017

1/2"



GDJD-2018

1/2" 3/4"



GDJD-2019

1/2"



GDJD-2020

1/2"



GDJD-2001

1/2"



GDJD-2002

1/2" 3/4"



GDJD-2003

1/2" 3/4"



GDJD-2004

1/2" 3/4"



GDJD-2021

1/2"



GDJD-2022

1/2"



GDJD-2023

1/2"



GDJD-2024

1/2"



GDJD-2005

1/2"



GDJD-2006

1/2" 3/4"



GDJD-2007

1/2"



GDJD-2008

1/2"



GDJD-2025

1/2" 3/4"

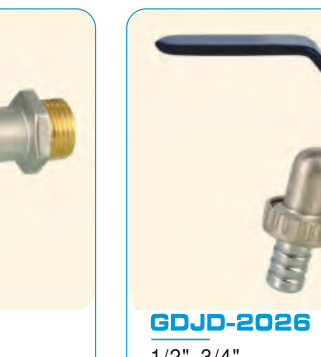

GDJD-2026

1/2" 3/4"

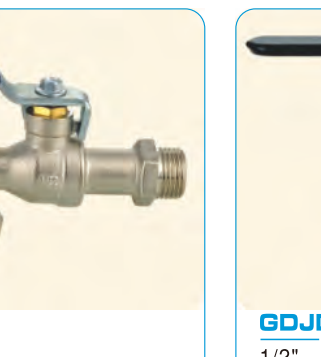

GDJD-2027

1/2"



GDJD-2009

1/2"



GDJD-2010 SOLDER

1/2"



GDJD-2011

1/2" 3/4"



GDJD-2012

1/2"



GDJD-2028

1/2" 3/4"

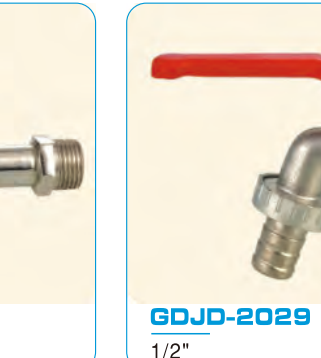

GDJD-2029

1/2"

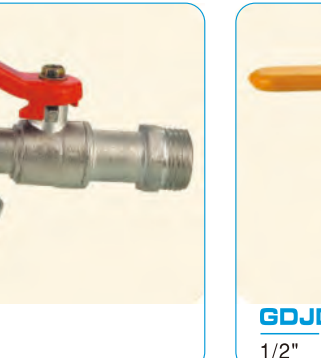

GDJD-2030

1/2"



GDJD-2013

1/2" 3/4"



GDJD-2014

1/2" 3/4"



GDJD-2015

1/2" 3/4"



GDJD-2016

1/2" 3/4"



GDJD-2031

1/2" 3/4"

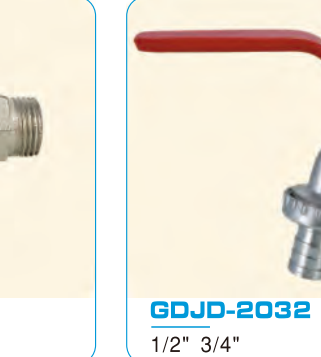

GDJD-2032

1/2" 3/4"

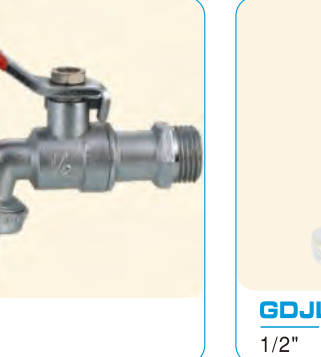

GDJL-1015

1/2"





GDJL-1001



GDJL-1002



GDJL-1003



GDJL-1004



GDJL-1029



GDJL-1030



GDJL-1031



GDJL-1032



GDJL-1007



GDJL-1008



1/2" 3/4"

GDJL-1010



1/2"

3/4"

GDJL-1011/26



GDJL-1033



GDJL-1034



GDJL-1035



GDJL-1036



GDJL-1012



GDJL-1013



GDJL-1016



GDJL-1017



GDJL-1037



GDJL-1038



GDJL-1039



GDJL-1040



GDJL-1019



GDJL-1020



GDJL-1021



GDJL-1022



GDJL-1061A



GDJL-1062A



GDJL-1063A



GDJL-1064A



GDJL-1023



GDJL-1024



GDJL-1027



GDJL-1028



GDJL-1065A



GDJL-1066A



GDJL-1067A



GDJL-1068A

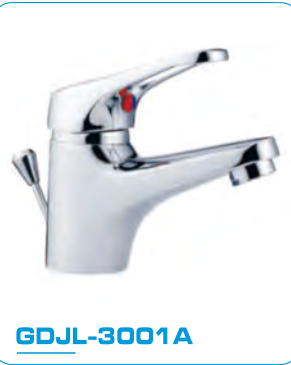

GDJL-3001A



GDJL-3002A



GDJL-3001E



GDJL-3001B



GDJL-3002B



GDJL-3003A



GDJL-3003B



GDJL-3001C

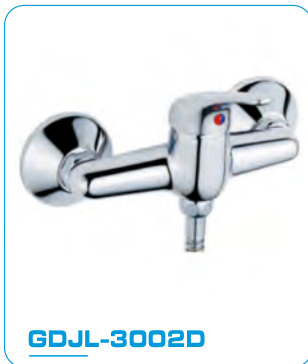

GDJL-3002D



GDJL-3003C



GDJL-3003D



GDJL-3001D



GDJL-3002E

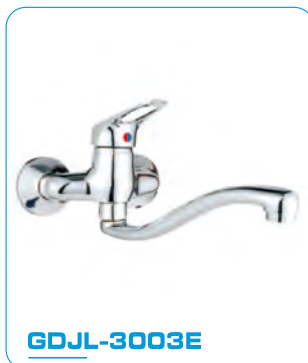

GDJL-3003E



GDJL-3003F



GDJL-3001F



GDJL-3002F



GDJL-3002C



GDJL-3004A



GDJL-3005A



GDJL-3006A



GDJL-3005E



GDJL-3004B



GDJL-3005B



GDJL-3006B



GDJL-3006E

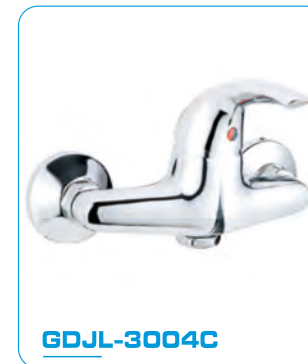

GDJL-3004C



GDJL-3005C



GDJL-3006C



GDJL-3006F

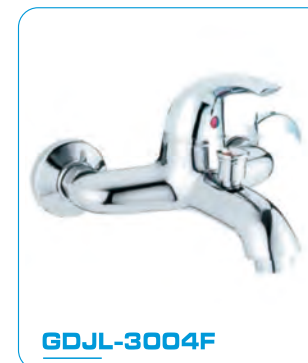

GDJL-3004F



GDJL-3005F



GDJL-3004E

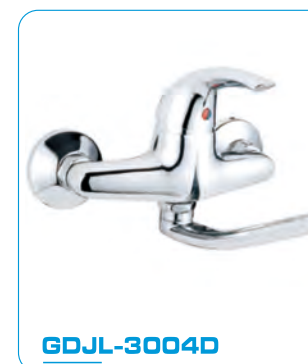

GDJL-3004D



GDJL-3005D



GDJL-3006D



GDJL-3024



GDJL-3025



GDJL-3026A



GDJL-3027A



GDJL-3028A



GDJL-3029A



GDJL-3026B



GDJL-3027B



GDJL-3028B



GDJL-3029B

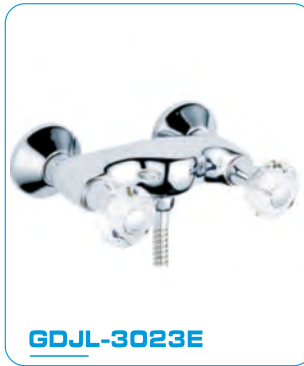

GDJL-3023E



GDJL-3023F

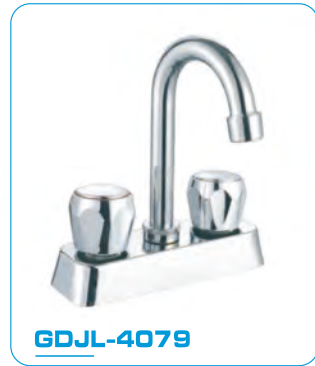

GDJL-4079



GDJL-4080



GDJL-4075



GDJL-4076



GDJL-4077



GDJL-4078



GDJL-4001



GDJL-4002



GDJL-4003



GDJL-4004



GDJL-4005



GDJL-4006



GDJL-4007



GDJL-4008



GDJL-4009



GDJL-4010



GDJL-4011



GDJL-4012



GDJL-4013



GDJL-4014



GDJL-4015



GDJL-4016



GDJL-4017



GDJL-4018



GDJL-4019



GDJL-4020



GDJL-4022



GDJL-4023



GDJL-4024



GDJL-4025

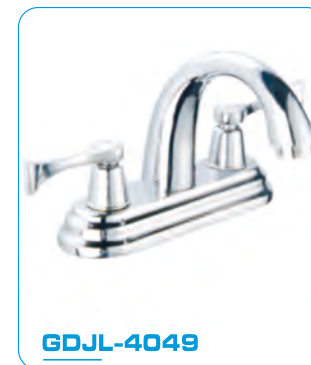

GDJL-4049



GDJL-4050

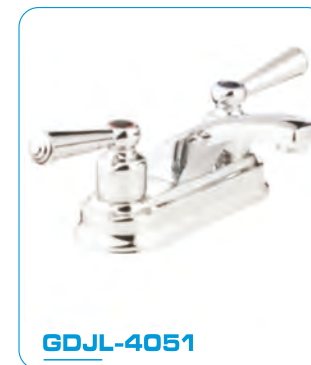

GDJL-4051

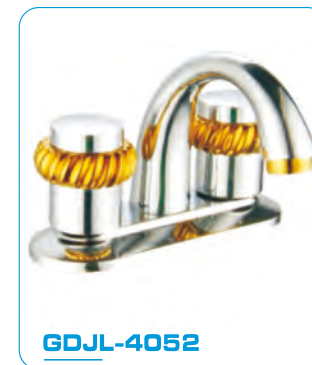

GDJL-4052



GDJL-4026



GDJL-4027

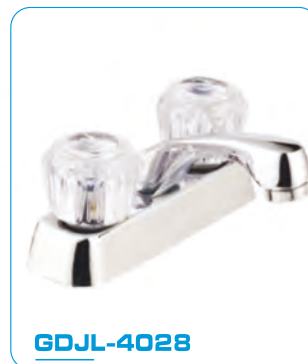

GDJL-4028

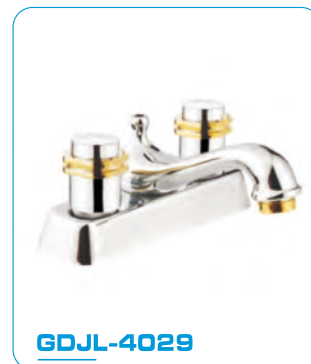

GDJL-4029



GDJL-4053



GDJL-4054



GDJL-4055

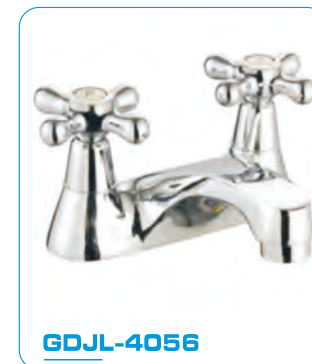

GDJL-4056



GDJL-4030

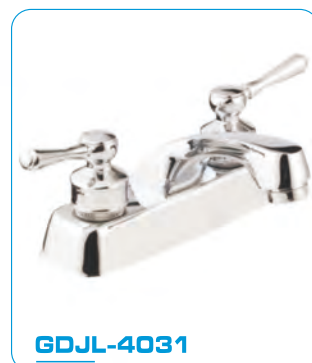

GDJL-4031

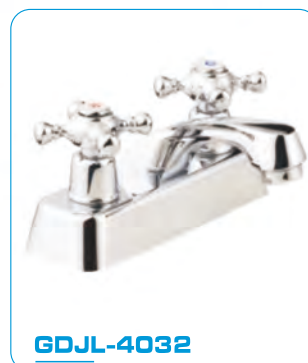

GDJL-4032

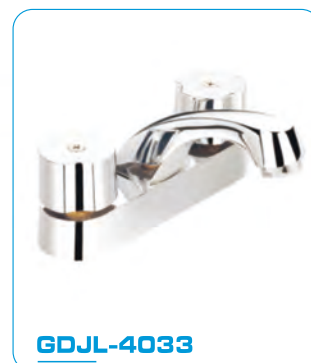

GDJL-4033

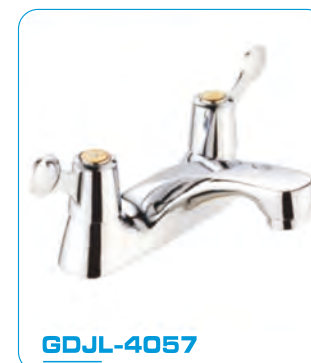

GDJL-4057



GDJL-4061



GDJL-4062



GDJL-4063



GDJL-4034



GDJL-4035



GDJL-4036



GDJL-4037



GDJL-4064



GDJL-4066



GDJL-4067



GDJL-4068



GDJL-4038



GDJL-4039

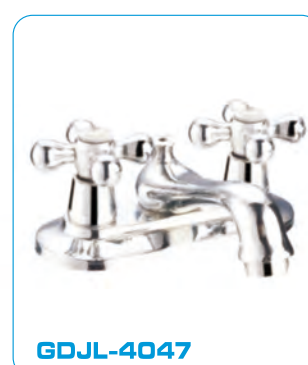

GDJL-4047



GDJL-4048



GDJL-4069



GDJL-4072



GDJL-4073



GDJL-4074



GDJL-8007



GDJL-8002



GDJL-8003



GDJL-8004

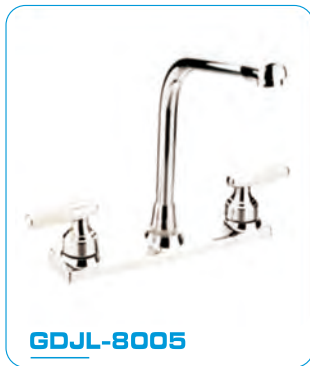

GDJL-8005



GDJL-8006



GDJL-8008



GDJL-8009



GDJL-8010



GDJL-8011



GDJL-8012



GDJL-8014



GDJL-8015



GDJL-8016

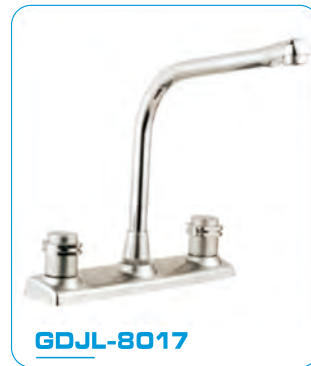

GDJL-8017



GDJL-8018



GDJL-8019



GDJL-8020



GDJL-8021

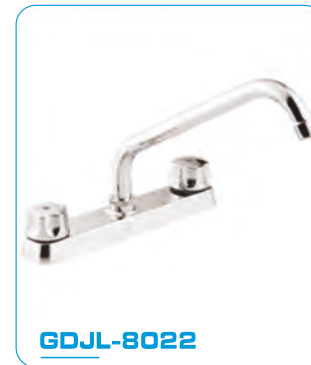

GDJL-8022



GDJL-8023



GDJL-8024



GDJL-8025



GDJL-8026



GDJL-8027



GDJL-8028



GDJL-8029



GDJL-8030



GDJL-8031



GDJL-8032



GDJL-8033



GDJL-8034



GDJL-8035



GDJL-8036



GDJL-8037



GDJL-8038



GDJL-8039



GDJL-8040



GDJL-8041



GDJL-8042

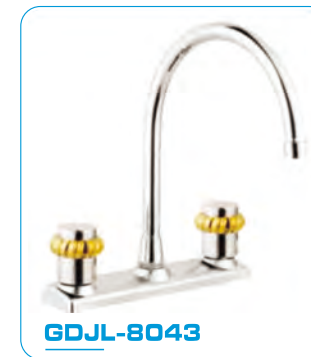

GDJL-8043



GDJL-8044



GDJL-8045



GDJL-8046

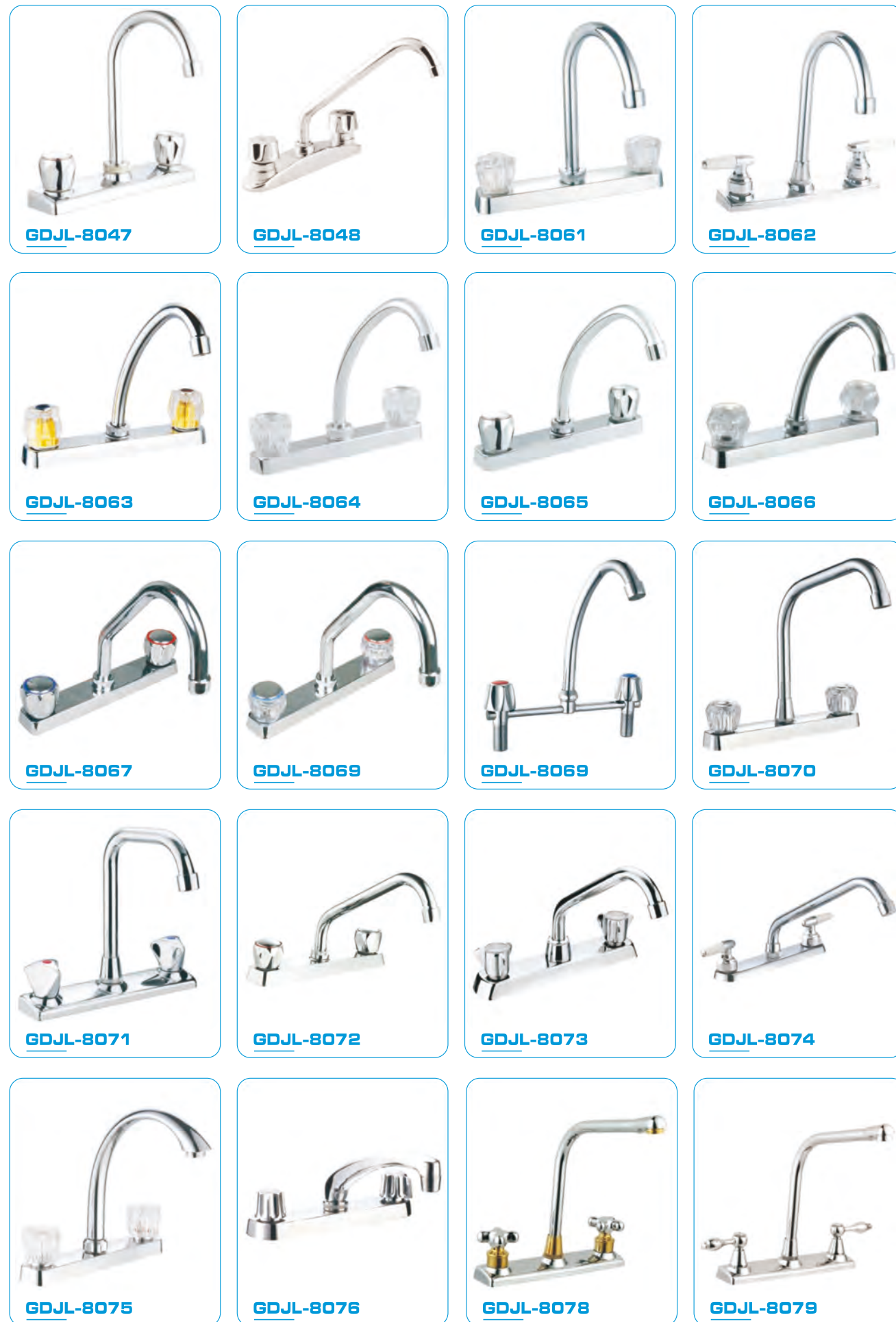

 100x100x60 <b>GDJL-5031</b>	 107x107x56 <b>GDJL-5032</b>	 86x86x58 <b>GDJL-5033</b>	 86x86x57 <b>GDJL-5034</b>
---	---	--	---

 153x153x60 <b>GDJL-5035</b>	 109x109x73 <b>GDJL-5036</b>	 101x101x84 <b>GDJL-5037</b>	 104x104x37 <b>GDJL-5038</b>
---	---	--	---

 250x250x60 <b>GDJL-5039</b>	 200x200x50 <b>GDJL-5040</b>	 200x200x50 <b>GDJL-5041</b>	 205x205x61 <b>GDJL-5042</b>
---	---	--	---

 material:ABS overhead shower 210x210x46 handle shower 250x112x18 <b>GDJL-5078</b>	 material:ABS overhead shower 238x238x117 handle shower 241x99x55 <b>GDJL-5079</b>	 material:ABS overhead shower 198x198x57 handle shower 242x100x14 <b>GDJL-5080</b>	 material:ABS overhead shower 250x167x59 handle shower 257x43x15 <b>GDJL-5081</b>
---	---	--	--

 material:ABS overhead shower 100x100x55 handle shower 236x100x27 <b>GDJL-5082</b>	 material:ABS hand shower 90x90 handle shower 260x93x67 <b>GDJL-5083</b>	 material:ABS overhead shower 90x90 handle shower 250x81x69 <b>GDJL-5084</b>	 material:ABS overhead shower 90x90 handle shower 250x81x69 <b>GDJL-5085</b>
---	---	--	---

 <b>GDSR001</b>	 <b>GDSR002</b>	 <b>GDSQ001</b>	 <b>GDSQ002</b>
---	---	---	---

 <b>GDYD001</b>	 <b>GDYD002</b>	 <b>GDYD003</b>	 <b>GDYD005</b>
---	---	---	---

 <b>GDYD007</b>	 <b>GDYD008</b>	 <b>GDYD009</b>	 <b>GDYD013</b>
---	---	---	---

 <b>GDYD015</b>	 <b>GDYD017</b>	 <b>GDYD018</b>	 <b>GDYD019</b>
---	---	---	---

 <b>GDYD020</b>	 <b>GDYD021</b>	 <b>GDYD023</b>	 <b>GDYD025</b>
---	---	---	---

 <b>GDYD026</b>	 <b>GDYD029</b>	 <b>GDYD030</b>
---	---	---

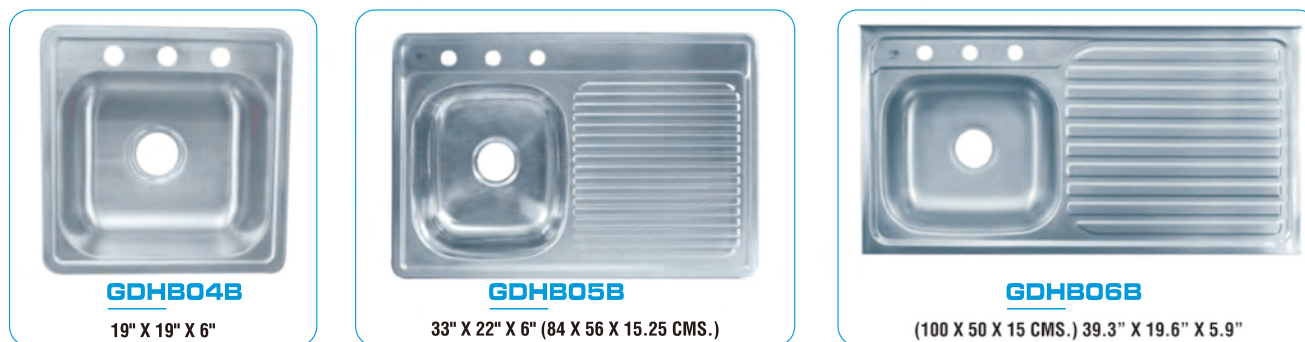
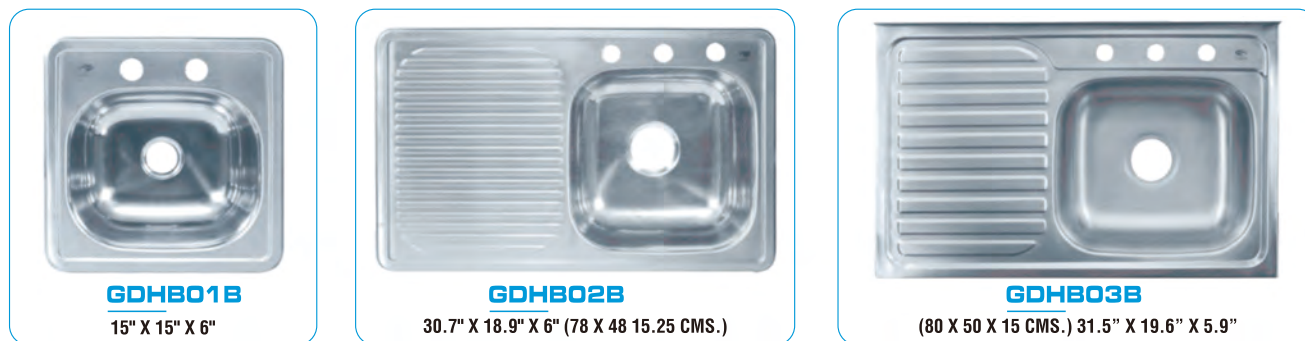







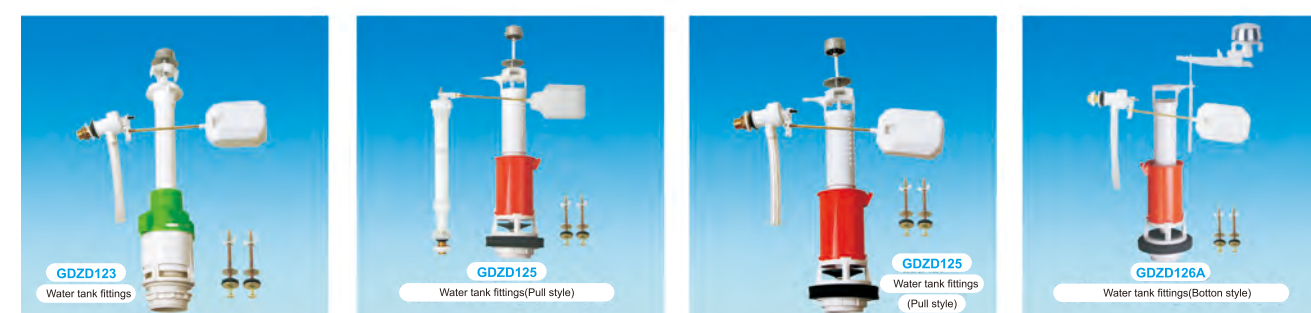
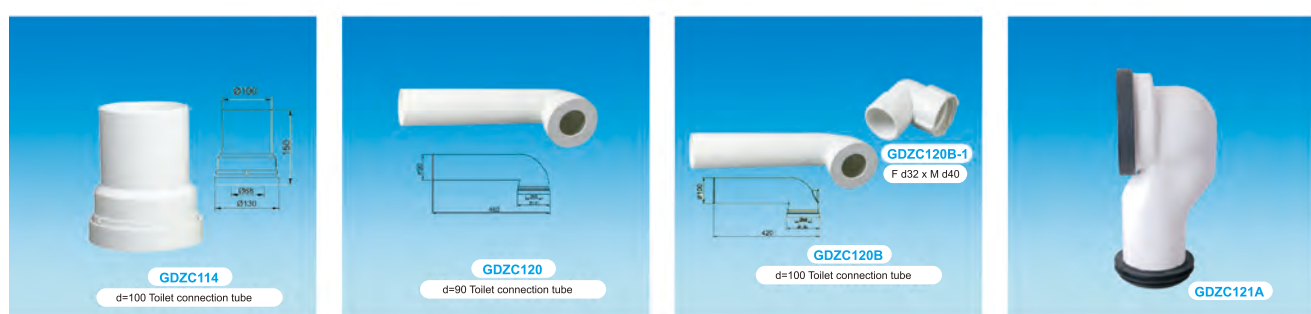



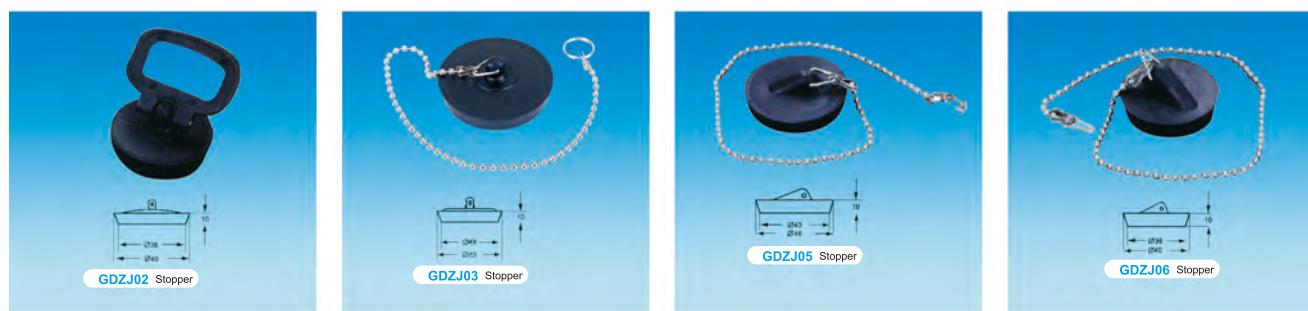
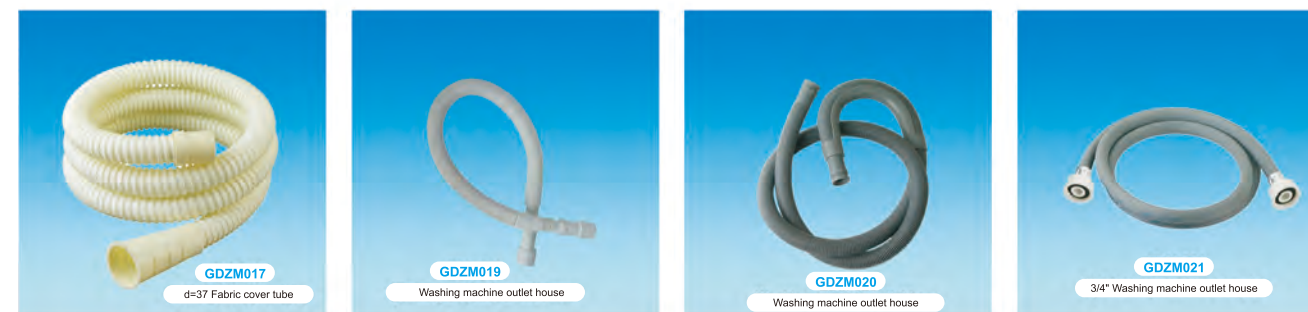
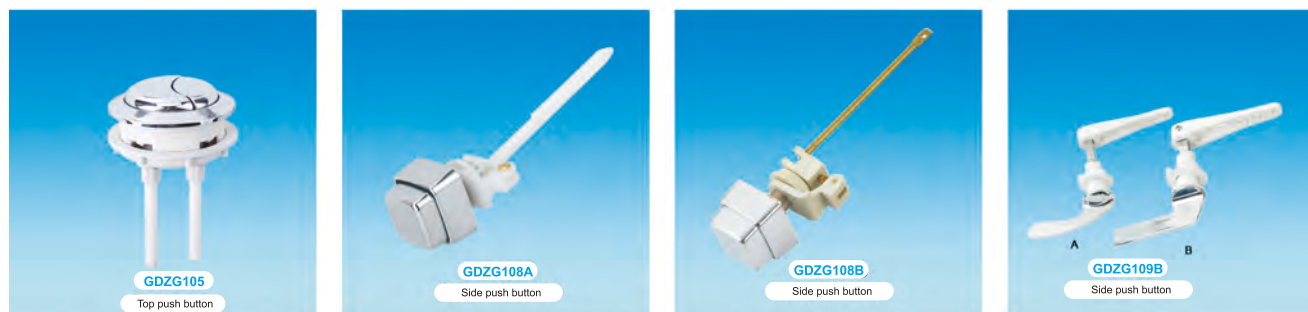

# PVC SCH40 PRESSURE PIPE & FITTINGS(ASTM D2466)



## PVC PRESSURE PIPE

ITEM NO.:AGZ01



Size	Nom	OUTER DIAMETER	WALL THICKNESS
1/2"		21.34	2.77
3/4"		26.67	2.87
1"		33.4	3.38
1-1/4"		42.16	3.56
1-1/2"		48.26	3.68
2"		60.32	3.91
2-1/2"		73.03	5.16
3"		88.9	5.49
4"		114.3	6.02
6"		168.3	7.11

## CAP

ITEM NO.:AN02

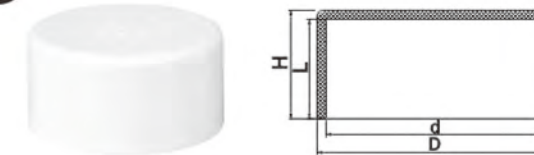

Size	Nom	d	D	L	H
1/2"		21.54	27.08	17.48	20.25
3/4"		26.87	32.61	18.28	21.13
1"		33.66	40.42	22.23	25.61
1-1/4"		42.42	49.54	23.83	27.39
1-1/2"		48.56	55.92	27.79	31.47
2"		60.63	68.45	29.36	33.27
2-1/2"		73.38	83.7	44.45	52.6
3"		89.31	100.13	47.63	52.96
4"		114.76	126.82	50.8	56.83
6"		168.83	183.06	76.2	88.31

## FEMALE ADAPTER

ITEM NO.:AN04

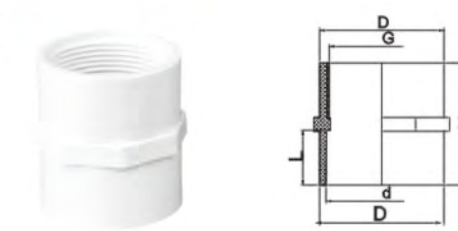

Size	Nom	d	D	G	L	H
1/2"		21.54	27.08	1/2"	17.48	39.71
3/4"		26.87	32.61	3/4"	18.28	40.79
1"		33.66	40.42	1"	22.23	49.62
1-1/4"		42.42	49.54	1-1/4"	23.83	51.83
1-1/2"		48.56	55.92	1-1/2"	27.79	56.21
2"		60.63	68.45	2"	29.36	59.62
2-1/2"		73.38	83.7	2-1/2"	44.45	73.4
3"		89.31	100.13	3"	47.63	93.89
4"		114.76	126.82	4"	50.8	99.6
6"		168.83	183.06	6"	76.2	132.8

## COUPLING

ITEM NO.:AN01



Size	Nom	d	D	L	H
1/2"		21.54	27.08	17.48	37.34
3/4"		26.87	32.61	18.28	38.9
1"		33.66	40.42	22.23	46.8
1-1/4"		42.42	49.54	23.83	50.04
1-1/2"		48.56	55.92	27.79	57.96
2"		60.63	68.45	29.36	61.1
2-1/2"		73.02	84.40	45	94.8
3"		89.31	100.13	47.63	100.02
4"		114.76	126.82	50.8	106.36
6"		168.83	183.06	76.2	158.75

## TEE

ITEM NO.:AN03

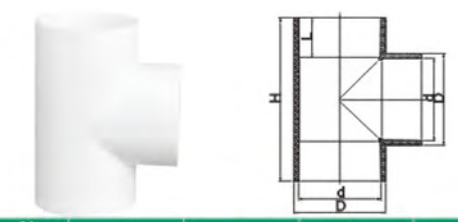

Size	Nom	d	D	L	H
1/2"		21.54	27.08	17.48	60.36
3/4"		26.87	32.61	18.28	64.64
1"		33.66	40.42	22.23	79.38
1-1/4"		42.42	49.54	23.83	92.12
1-1/2"		48.56	55.92	27.79	106.38
2"		60.63	68.45	29.36	122.22
2-1/2"		73.02	84.40	45	168.2
3"		89.31	100.13	47.63	187.34
4"		114.76	126.82	50.8	219.08
6"		168.83	183.06	76.2	230.2

## MALE ADAPTER

ITEM NO.:AN05

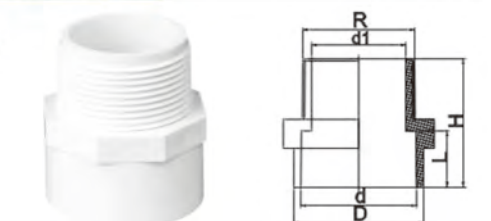

Size	Nom	d	D	d1	R	L	H
1/2"		21.54	27.08	13.8	1/2"	17.48	39.71
3/4"		26.87	32.61	18.85	3/4"	18.28	41.29
1"		33.66	40.42	24.3	1"	22.23	49.62
1-1/4"		42.42	49.54	32.46	1-1/4"	23.83	51.83
1-1/2"		48.56	55.92	38.1	1-1/2"	27.79	56.18
2"		60.63	68.45	49.24	2"	29.36	58.62
2-1/2"		73.38	83.7	61.3	2-1/2"	44.45	73.4
3"		89.31	100.13	73.66	3"	47.63	93.89
4"		114.76	126.82	97.18	4"	50.8	99.6
6"		168.83	183.06	149.8	6"	76.2	132.8
3/4**1/2"		26.87	32.61	13.8	1/2"	18.5	43.35
1/2**3/4"		27.08	27.08	19	3/4"	17.5	42.75
1*3/4"		33.66	40.42	19	3/4"	22.23	47.78
3/4**1"		33.66	32.61	24	1"	18.5	58.35

**90 DEG ELBOW**

ITEM NO.:AN06



Size	Nom	d	D	L
1/2"		21.54	27.08	17.48
3/4"		26.87	32.61	18.28
1"		33.66	40.42	22.23
1-1/4"		42.42	49.54	23.83
1-1/2"		48.56	55.92	27.79
2"		60.63	68.45	29.36
2-1/2"		73.02	84.40	45
3"		89.31	100.13	47.63
4"		114.76	126.82	50.8
6"		168.83	183.06	76.2

**45 DEG ELBOW**

ITEM NO.:AN07



Size	Nom	d	D	L
1/2"		21.54	27.08	17.48
3/4"		26.87	32.61	18.28
1"		33.66	40.42	22.23
1-1/4"		42.42	49.54	23.83
1-1/2"		48.56	55.92	27.79
2"		60.63	68.45	29.36
2-1/2"		73.02	84.40	45
3"		89.31	100.13	47.63
4"		114.76	126.82	50.8
6"		168.83	183.06	76.2

**FEMALE ELBOW**

ITEM NO.:AN09



Size	Nom	d	D	NPT	L
1/2"		21.54	27.08	1/2"	17.48
3/4"		26.87	32.61	3/4"	18.28
1"		33.66	40.42	1"	22.23
1-1/4"		42.42	49.54	1-1/4"	23.83
1-1/2"		48.56	55.92	1-1/2"	27.79
2"		60.63	68.45	2"	29.36

**REDUCING BUSHING**

ITEM NO.:AN11



Size	Nom	D1	d1	D2	d2	H	L1	L
3/4" x 1/2"		32.87	21.54	26.67	14.68	17.48	18.26	21.26
1" x 1/2"		40.0	21.54	33.4	14.68	17.48	22.23	25.23
1" x 3/4"		40.0	26.87	33.4	18.8	18.26	22.23	25.23
1-1/4" x 1/2"		49.0	21.54	42.16	14.68	17.48	23.83	26.83
1-1/4" x 3/4"		49.0	26.87	42.16	18.8	18.26	23.83	26.83
1-1/4" x 1"		49.0	33.66	42.16	25.15	22.23	23.83	26.83
1-1/2" x 1/2"		59.0	21.54	48.26	14.68	17.48	27.79	30.79
1-1/2" x 3/4"		59.0	26.87	48.26	18.8	18.26	27.79	30.79
1-1/2" x 1"		59.0	33.66	48.26	25.15	22.23	27.79	30.79
1-1/2" x 1-1/4"		59.0	42.42	48.26	33.91	23.83	27.79	30.79
2" x 1/2"		70	21.54	60.33	14.68	17.48	29.36	34.36
2" x 3/4"		70	26.87	60.33	18.8	18.26	29.36	34.36
2" x 1"		70	33.66	60.33	25.15	22.23	29.36	34.36
2" x 1-1/4"		70	42.42	60.33	33.91	23.83	29.36	34.36
2" x 1-1/2"		70	48.56	60.33	39.73	27.79	29.36	34.36
3" x 1-1/2"		95	48.56	88.9	39.73	27.79	47.63	52.63
3" x 2"		95	60.63	88.9	51.33	29.36	47.63	52.63
4" x 2"		121	60.63	114.3	51.33	29.36	50.8	55.8
4" x 3"		121	89.31	114.3	76.4	47.63	50.8	55.8
6" x 4"		178.9	114.76	168.28	100.61	50.8	76.2	81.2

**FEMALE TEE**

ITEM NO.:AN08



Size	Nom	d	D	NPT	L	H
1/2"		21.54	27.08	1/2"	17.48	60.36
3/4"		26.87	32.61	3/4"	18.28	64.64
1"		33.66	40.42	1"	22.23	79.38
1-1/2"		48.56	55.92	1-1/2"	27.79	106.38
1-1/4"		42.42	50		23.9	92.26
2"		60.63	68.45		29.4	122.3

**REDUCING TEE**

ITEM NO.:AN10

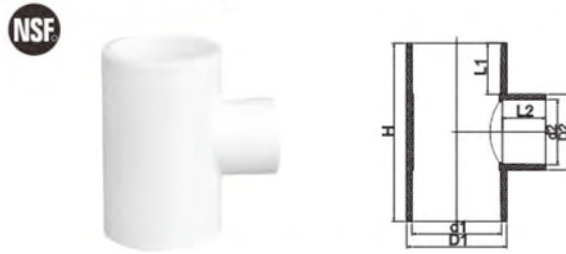

Size	Nom	d1	d2	D1	D2	L1	L2	H
3/4" x 1/2"		26.87	21.54	32.61	27.08	18.28	17.48	64.64
1" x 1/2"		33.66	21.54	40.42	27.08	22.23	17.48	79.38
1" x 3/4"		33.66	26.87	40.42	32.61	22.23	18.28	79.38
2" x 3/4"		60.63	26.87	68.45	32.61	29.36	18.28	122.22

**REDUCING COUPLING**

ITEM NO.:AN12



Size	Nom	D2	d2	D1	d1	H	L2	L1
3/4" x 1/2"		32.61	26.87	27.08	21.54	44.39	18.28	17.48
1" x 1/2"		40.42	33.66	27.08	21.54	57.09	21.23	17.48
1" x 3/4"		40.42	33.66	32.61	26.87	55.88	21.23	18.28
1-1/4" x 3/4"		49.54	42.42	32.61	26.87	62.93	23.84	18.28
1-1/4" x 1"		49.54	42.42	40.42	33.66	61.9	23.84	22.23
1-1/2" x 3/4"		55.92	48.56	32.61	26.87	71.69	27.79	18.28
1-1/2" x 1"		55.92	48.56	40.42	33.66	70.22	27.79	22.23
1-1/2" x 1-1/4"		55.92	48.56	49.54	42.42	66.19	27.79	23.84
2" x 1"		68.45	60.63	40.42	33.66	76.79	29.36	22.23
2" x 1-1/4"		68.45	60.63	49.54	42.42	78.39	29.36	23.84
2" x 1-1/2"		68.45	60.63	49.54	42.42	82.35	29.36	23.84
2-1/2" x 1-1/2"		83.7	73.38	55.92	48.56	100.66	44.45	27.79
2-1/2" x 2"		83.7	73.38	68.45	60.63	102.23	44.45	29.36
3" x 2"		100.13	89.31	68.45	60.63	111.01	47.63	29.36
3" x 2-1/2"		100.13	89.31	83.7	73.38	126.1	47.63	44.45
4" x 2"		126.82	114.76	68.45	60.63	121.18	50.8	29.36
4" x 2-1/2"		126.82	114.76	83.7	73.38	136.27	50.8	44.45
4" x 3"		126.82	114.76	100.13	89.31	139.45	50.8	47.63

**REDUCING FEMALE TEE**

ITEM NO.:AN14



Size	Nom	d1	d2	d3	NPT	L1	L2	H
3/4" x 1/2"		32.61	26.87	28.8	1/2"	17.48	19.85	64.64
1" x 1/2"		40.42	33.66	28.8	1/2"	22.23	19.85	79.38
1" x 3/4"		40.42	33.66	34.39	3/4"	22.23	20.15	79.38

**PLUG**

ITEM NO.:AN16



Size	Nom	d	NPT	L	h	H
1/2"		13.8	1/2"	27	19.85	24.85
3/4"		18.85	3/4"	32	20.15	25.15
1"		24.3	1"	42	25.01	32.01
1-1/4"		32.46	1-1/4"	50	25.62	34.62
1-1/2"		38.1	1-1/2"	60	26.04	35.04
2"		49.24	2"	70	26.88	36.88

**REDUCING FEMALE ELBOW**

ITEM NO.:AN13



Size	Nom	d1	d2	d3	NPT	L
3/4" x 1/2"		26.87	32.61	28.8	1/2"	18.28
1" x 1/2"		33.66	40.42	28.8	1/2"	22.23
1" x 3/4"		33.66	40.42	34.49	3/4"	22.23

**REDUCING BUSHING (AN15) MIP\*FIP**

ITEM NO.:AN15

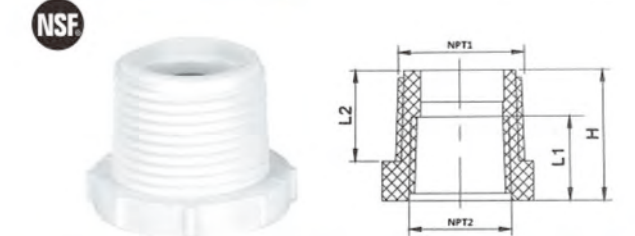

Size	Nom	NPT1	NPT2	L1	L2	H
3/4" x 1/2"		3/4"	1/2"	19.85	20.15	26.15
1" x 1/2"		1"	1/2"	19.85	25.01	31.01
1" x 3/4"		1"	3/4"	20.15	25.01	31.01

**PIPE CLIP**

ITEM NO.:AN17



Size	Nom	D	L	L1	H	R
1/2"		14.7	3.9	17.4	28.4	21.34
3/4"		19.7	4.3	21.7	34.2	26.67
1"		21.0	5.0	27.8	45.4	33.40
1-1/4"		25.3	5.1	31.5	51.3	42.16
1-1/2"		31.8	5.2	36.4	58.9	48.26
2"		44.4	6.8	40.6	71.5	60.32
2-1/2"		52	6.5	51	92.5	73
3"		62.1	7.0	53.3	98.6	88.90
4"		88.4	7.3	73.3	129.8	114.30
6"		129.3	6.8	96.85	190.2	168.3

**COMPRESSION COUPLING** ITEM NO.:AN18



Size	Nom	d1	d2	D	L
1/2"	24	22	43	80	
3/4"	28	29	50.5	90	
1"	35	36	61	96	
1-1/4"	43	44	70	110	
1-1/2"	52	53	81	122	
2"	65	67	100	155	
2-1/2"	77	82	115	188	
3"	93	94	130	221	
4"	116	118	157	276	
6"	169	170	210	313	

**UNION** ITEM NO.:AN19-1



Size	Nom	d	D	L	H
1/2"	21.54	27.08	17.48	20	
3/4"	26.87	32.61	18.26	20.3	
1"	33.66	40.41	22.23	24.3	
1-1/2"	48.56	55.93	27.79	28.9	
2"	60.63	68.45	29.36	30.9	

**FEMALE COUPLING WITH BRASS** ITEM NO.:AN21

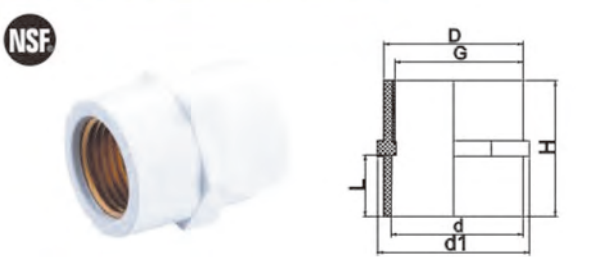

Size	Nom	d	d1	G	D	L	H
1/2"	21.34	33.1	1/2"	29	16	36.6	
3/4"	26.67	39.5	3/4"	34.9	19.1	42.9	

**UNION** ITEM NO.:AN19



Size	Nom	d	D	L	H
1/2"	21.54	27.08	46.5	24	
3/4"	26.87	32.61	57.5	24	
1"	33.66	40.42	68	24	
1-1/4"	42.42	49.54	81	24	
1-1/2"	48.56	55.92	90	31	
2"	60.63	68.45	110	31	
2-1/2"	73.38	83.7	118	38.4	
3"	89.31	100.13	150	45	
4"	114.76	126.82	190	53	

**FEMALE ELBOW WITH BRASS** ITEM NO.:AN20

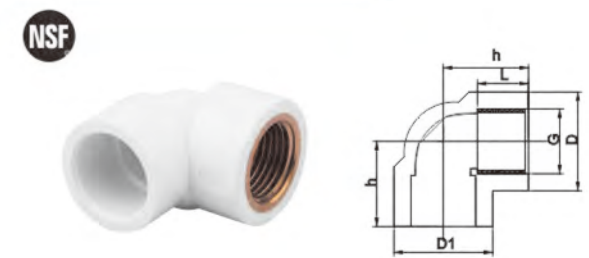

Size	Nom	G	D	D1	L	h
1/2"	1/2"	32.0	29.4	12.1	29.1	
3/4"	3/4"	38.1	36.0	12.8	33.6	

**FEMALE TEE WITH BRASS** ITEM NO.:AN22

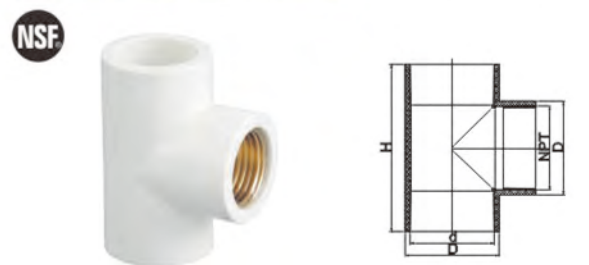

Size	Nom	d	D	NPT	H
1/2"	21.34	28	1/2"	74.0	

**PVC FEMALE BUSHING** ITEM NO.:AN23



Size	Nom	A	B	C	H1
1/2x3/8"	21.54	21.23	3/8NPT	17.48	
3/4"x1/2"	26.87	26.57	1/2NPT	18.26	
1"x3/4"	33.66	33.27	3/4NPT	22.23	
1"x1/2"	33.66	33.27	1/2NPT	22.23	
2"x1/2"	60.63	60.17	1/2NPT	29.36	
2"x3/4"	60.63	60.17	3/4NPT	29.36	
2"x1"	60.63	60.17	1NPT	29.36	
2"x1-1/4"	60.63	60.17	1-1/4NPT	29.36	
2"x1-1/2"	60.63	60.17	1-1/2NPT	29.36	

**PVC SADDLE CLIP** ITEM NO.:AN25



Size	Nom	L	L1	A	B	C	d
2"x1/2"	118	62.9	21.54	27.1	17.5	58	
2"x3/4"	118	62.9	26.87	32.6	18.3	58	
3"x1/2"	148	91	21.54	27.1	17.5	88.5	
3"x2/4"	148	91	26.87	32.6	18.3	88.5	
4"x1/2"	189.7	115.1	21.54	27.1	17.5	111	
4"x3/4"	189.7	115.1	26.87	32.6	18.3	111	

**PVC LONG REDUCING COUPLING** ITEM NO.:AN27

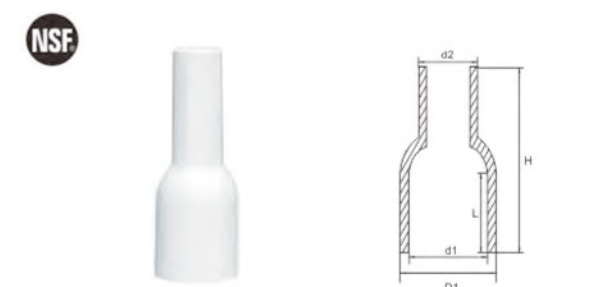

Size	Nom	D	d1	L	d2	H
1/2x3/8"	27.39	21.54	17.71	17.04	61.39	
1/2x3/4"	32.91	26.87	18.46	21.23	71.7	

**PVC STREET ELBOW** ITEM NO.:AN24

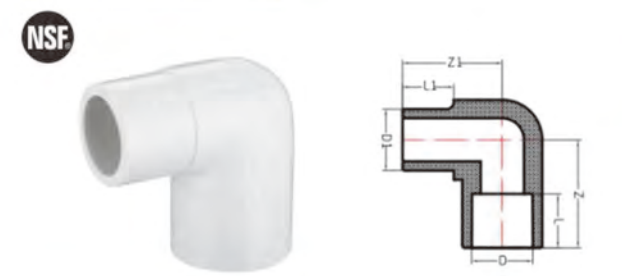

Size	Nom	D	D1	L	L1	Z	Z1
1/2"	21.34	21.34	17.5	17.5	38.0	35.0	
3/4"	26.67	26.67	18.5	18.5	40.5	39.5	
1"	33.40	33.40	22.5	22.5	48.0	46.5	

**PVC CROSS** ITEM NO.:AN26

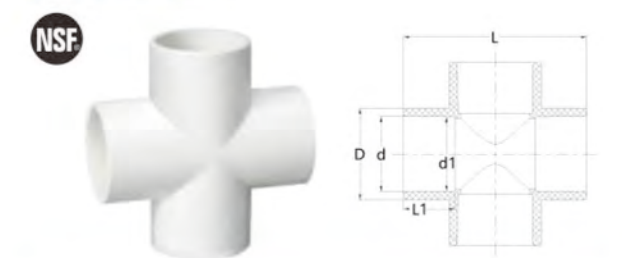

Size	Nom	D	L	L1	d	d1
1/2"	27.07	60.36	17.48	21.53	21.23	
3/4"	32.61	65.12	18.26	26.87	26.57	
1"	40.5	87.5	23	33.66	33.27	
1-1/4"	49.6	100	25	42.42	42.04	
1-1/2"	55.96	115	30	48.56	48.1	
2"	68.6	140	31	60.63	60.17	
2-1/2"	83.8	170	45	73.38	72.85	
3"	100	190	48	89.3	88.7	
4"	126.8	225	51	114.8	114.1	

**PVC Y TEE** ITEM NO.:AN28



Size	Nom	L	H	L1	D1	D
1/2"	88	65	17.5	27.08	21.54	
3/4"	100	80	18.3	32.61	26.87	
1"	120	96	21.5	40.42	33.66	

**MALE ELBOW**

ITEM NO.:AN29

NSF



Size	Nom	L	D	d1	d2
1/2"		22	27.08	21.23	21.54

**THREE WAY ELBOW**

ITEM NO.:AN30

NSF



Size	Nom	L	D	D1	d1	d2
1/2"		25	27.08	27.08	21.23	21.54

**PVC CLAMP**

ITEM NO.:AN31



Size	Nom	NPT	NPT1	D	D1	L	L1	L2	L3	L4
2"x1/2"	1-1/4"	1/2"	60	68	9.5	28.4	41.8	54	2	
2"x3/4"	3/4"	1/2"	60	68	9.5	28.4	41.8	54	2	
3"x1/2"	1-1/4"	1/2"	89.2	99	9.5	28.4	41.8	67.1	2	
3"x3/4"	1-1/4"	3/4"	89.2	99	9.5	28.4	41.8	67.1	2	
4"x1/2"	1-1/4"	1/2"	115.3	126.5	9.5	28.4	41.8	81.3	2	
4"x3/4"	1-1/4"	3/4"	115.3	126.5	9.5	28.4	41.8	81.3	2	
6"x1/2"	1-1/4"	1/2"	169.2	179	9.5	28.4	41.8	108.4	2	
6"x3/4"	1-1/4"	3/4"	169.2	179	9.5	28.4	41.8	108.4	2	

**FEMALE SOCKET WITH BRASS**

ITEM NO.:AN32

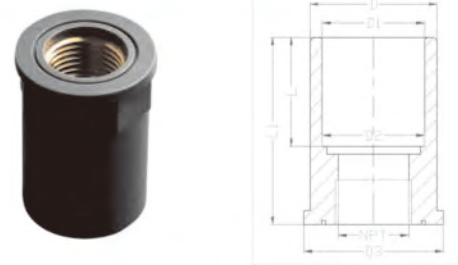

Size	Nom	NPT	D	D1	D2	D3	L	L1
1/2x1/2	1/2"	27.01	21.54	21.23	34.2	35.6	47	
3/4Sx3/4T	3/4"	32.54	26.87	26.57	36.3	30.2	48.3	
3/4Sx1/2T	3/4"	32.54	26.87	26.57	36.6	28.7	49.1	

**FEMALE ELBOW WITH BRASS**

ITEM NO.:AN33



Size	Nom	NPT	D	D1	D2	D3	L	L1
1/2x1/2	1/2"	27.08	21.54	21.23	33.84	31.4	41.6	
3/4Sx3/4T	3/4"	32.61	26.87	26.57	38.78	29.3	52.2	
3/4Sx1/2T	3/4"	32.61	26.87	26.57	34.58	28	48.6	

**FEMALE TEE WITH BRASS**

ITEM NO.:AN34

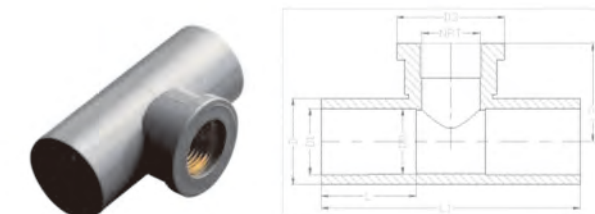

Size	Nom	NPT	D	D1	D2	D3	L	L1	L2
1/2x1/2	1/2"	27.08	21.54	21.23	34.8	30.8	84	32	
3/4Sx3/4T	3/4"	32.61	26.87	26.57	37.9	29.3	81.2	33.8	
3/4Sx1/2T	1/2"	32.61	26.87	26.57	37.8	29	81.8	31	

**MALE SOCKET WITH BRASS**

ITEM NO.:AN35

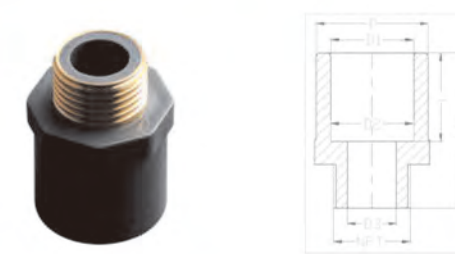

Size	Nom	NPT	D	D1	D2	D3	L	L1
1/2x1/2	1/2"	27.01	21.54	21.23	14.68	23.09	40.59	

**PVC PLUG(SOCKET&THREAD)**

ITEM NO.:AN36



Size	Nom	NPT	D	D1	D2	L	L1	L2	L3
2"x1-1/2"	2"	63	48.56	48.11	27.8	33	37	28	

**P-TRAP**

ITEM NO.:AN37



Size	Nom	L	H	D
3/4"		205	114	26.67

**R-TRAP**

ITEM NO.:AN38



Size	Nom	L	H	D
3/4"		250	77	26.67

**J-TRAP**

ITEM NO.:AN39



Size	Nom	L	H1	H2	D
3/4"		119	114	147	26.67

**MALE AND FEMALE ADAPTER**

ITEM NO.:AN40

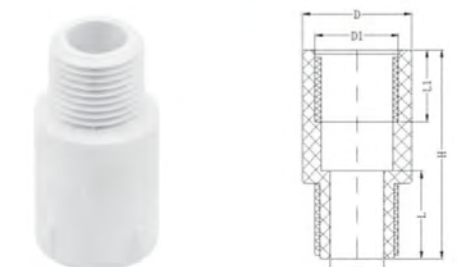

Size	Nom	H	L	L1	D	D1	D2
1/2"		52.5	22	18	27.5	1/2"	13.3

**PVC CONDUIT PIPE**

ITEM NO.:MGZ01



Size	OUTER DIAMETER(MM)	WALL THICKNESS(MM) THICK SCH40	WALL THICKNESS(MM) THIN
1/2"	21.34	2.77	1.4/1.6
3/4"	26.67	2.87	1.6
1"	33.4	3.38	1.7
1-1/4"	42.16	3.56	1.8
1-1/2"	48.26	3.68	2.1
2"	60.32	3.91	2.2
2-1/2"	73.02	5.16	2.4
3"	88.9	5.49	3.0
4"	114.3	6.02	3.4
6"	168.28	7.1	4.11

**PVC CONDUIT BEND (SINGLE ENDS BELL)**

ITEM NO.:CB01



Size Nom	A	B
1/2"	21.54	21.34
3/4"	26.87	26.67
1"	33.66	33.4
1-1/4"	42.42	42.16
1-1/2"	48.56	48.26
2"	60.63	60.33
3"	89.3	88.9
4"	114.76	114.3
6"	168.8	168.28

**PVC CONDUIT BEND (DOUBLE ENDS BELL)**

ITEM NO.:CB02



Size Nom	A	B
1/2"	21.54	21.23
3/4"	26.87	26.57
1"	33.66	33.27
1-1/4"	42.42	42.04
1-1/2"	48.56	48.11
2"	60.63	60.17
3"	89.3	88.9
4"	114.76	114.3

**BOX OCTAGONAL**

ITEM NO.:CB03

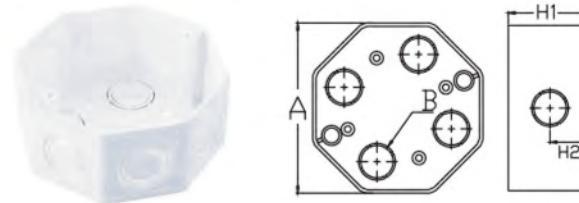

Size Nom	A	B	H1	H2
4"	102	27	48	23

**HANDY BOX**

ITEM NO.:CB04

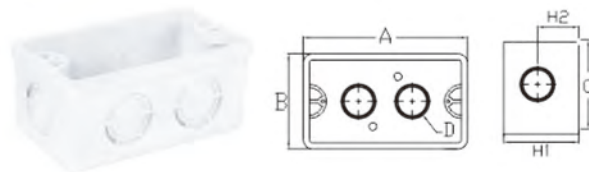

Size Nom	A	B	C	D	H1	H2
4"x2"	107	62	58	22	49	27

**BOX WITH CAP**

ITEM NO.:CB05

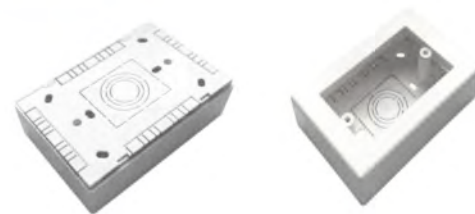

Size
4"x2"

**ROUND BOX**

ITEM NO.:CB06



Size
4"

**PVC CONDUIT MALE CONECTOR**

ITEM NO.:CB09



Size Nom	A	B	C	D
1/2"	21.54	21.23	17.48	1/2NPT
3/4"	26.87	26.57	18.26	3/4NPT
1"	33.66	33.27	22.23	1NPT
1-1/4"	42.42	42.04	23.83	1-1/4NPT
1-1/2"	48.56	48.11	27.79	1-1/2NPT
2"	60.63	60.17	29.36	2NPT
2-1/2"	73.41	72.85	45	2-1/2NPT
3"	89.28	88.7	46.25	3NPT
4"	114.68	114.07	49	4NPT

**SQUARE BOX**

ITEM NO.:CB08



Size Nom	A	B	C	D	H1	H2
4"	107	107	28	22	48.5	25.5

**PVC-U CSA COUPLING**

ITEM NO.:CB10



Size Nom	d	D	L	H
1-1/4"	42.59	48.7	23.83	51
1-1/2"	48.72	54.82	26.97	58
2"	60.78	67.38	28.58	61.16
2-1/2"	73.41	81.79	45	95
3"	89.28	100.26	46.25	98.5
4"	114.68	126.72	49	106

# PVC SCH80 PRESSURE PIPE & FITTINGS(ASTM D2467)



## PVC PRESSURE PIPE

ITEM NO.:S38



Size	Nom	OUTER DIAMETER	WALL THICKNESS
1/2"		21.34	3.7
3/4"		26.67	3.9
1"		33.4	4.6
1-1/4"		42.16	4.9
1-1/2"		48.26	5.1
2"		60.32	5.5
2-1/2"		73.03	7.1
3"		88.9	7.6
4"		114.3	8.6
6"		168.3	10.97

## 90 DEG ELBOW

ITEM NO.:S02

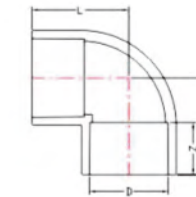

Size	Nom	D	L	Z
1/2"		21.34	50.2	24.0
3/4"		26.67	56.5	27.0
1"		33.40	62.5	30.0
1-1/4"		42.16	68.5	33.0
1-1/2"		48.26	74.5	36.0
2"		60.32	80.5	39.0
2-1/2"		73.02	97.0	46.0
3"		88.90	103.0	49.0
4"		114.30	123.0	59.0

## EQUAL TEE

ITEM NO.:S04



Size	Nom	D	L	Z
1/2"		21.34	36.5	24.0
3/4"		26.67	42.5	27.0
1"		33.40	49.5	30.0
1-1/4"		42.16	56.0	33.0
1-1/2"		48.26	63.0	36.0
2"		60.32	73.5	39.0
2-1/2"		73.02	86.5	46.0
3"		88.90	100.0	49.0
4"		114.30	124.0	59.0

## COUPLING

ITEM NO.:S01

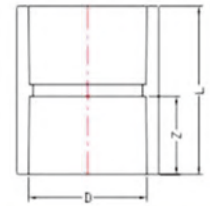

Size	Nom	D	L	Z
1/2"		21.34	50.2	24.0
3/4"		26.67	56.5	27.0
1"		33.40	62.5	30.0
1-1/4"		42.16	68.5	33.0
1-1/2"		48.26	74.5	36.0
2"		60.32	80.5	39.0
2-1/2"		73.02	97.0	46.0
3"		88.90	103.0	49.0
4"		114.30	123.0	59.0

## 45 DEG ELBOW

ITEM NO.:S03

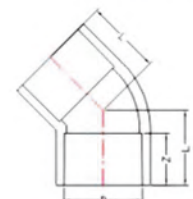

Size	Nom	D	L	Z
1/2"		21.34	30.5	24.0
3/4"		26.67	34.5	27.0
1"		33.40	39.5	30.0
1-1/4"		42.16	45.0	33.0
1-1/2"		48.26	49.0	36.0
2"		60.32	54.5	39.0
2-1/2"		73.02	66.0	46.0
3"		88.90	72.0	49.0
4"		114.30	88.0	59.0

## REDUCING TEE

ITEM NO.:S05

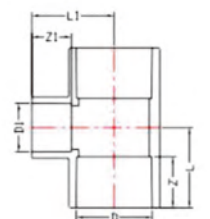

Size	Nom	D	L	Z	D1	L1	Z1
3/4"X1/2"		26.67	39.5	27.0	21.34	39.0	24.0
1"X1/2"		33.40	42.5	30.0	21.34	42.0	24.0
1"X3/4"		33.40	45.5	30.0	26.67	45.5	27.0
1-1/4"X3/4"		42.16	48.5	33.0	26.67	50.0	27.0
1-1/4"X1"		42.16	51.5	33.0	33.40	53.0	30.0
1-1/2"X1"		48.26	56.0	36.0	33.40	57.5	30.0
1-1/2"X1-1/4"		48.26	61.0	36.0	42.16	61.0	33.0
2"X1-1/4"		60.30	64.0	39.0	42.16	67.0	33.0
2"X1-1/2"		60.32	64.0	39.0	48.26	70.0	36.0
2-1/2"X1-1/2"		73.02	74.0	46.0	48.26	76.5	36.0
2-1/2"X2"		73.02	80.0	46.0	60.32	79.5	39.0
3"X2"		88.90	83.0	49.0	60.32	87.5	39.0
3"X2-1/2"		88.9	89.5	49.0	73.02	107.0	46.0
4"X2-1/2"		114.30	99.5	59.0	73.02	107.0	46.0
4"X3"		114.30	107.5	59.0	88.9	110.0	49.0

**REDUCING COUPLING**

ITEM NO.:S06

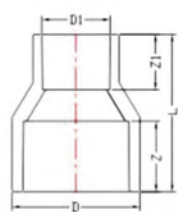

Size	Nom	D	L	Z	D1	Z1
3/4"X1/2"	26.67	60.0	27.0	21.34	24.0	24.0
1"X1/2"	33.40	63.0	30.0	21.34	24.0	24.0
1"X3/4"	33.40	67.5	30.0	26.67	27.0	27.0
1-1/4"X3/4"	42.16	75.0	33.0	26.67	27.0	27.0
1-1/4"X1"	42.16	69.0	33.0	33.40	30.0	30.0
1-1/2"X1"	48.26	77.0	36.0	33.40	30.0	30.0
1-1/2"X1-1/4"	48.26	83.5	36.0	42.16	33.0	33.0
2"X1-1/4"	60.32	89.0	39.0	42.16	33.0	33.0
2"X1-1/2"	60.32	94.0	39.0	48.26	36.0	36.0
2-1/2"X1-1/2"	73.02	99.0	46.0	48.26	36.0	36.0
2-1/2"X2"	73.02	102.0	46.0	60.32	39.0	39.0
3"X2"	88.90	106.5	49.0	60.32	39.0	39.0
3"X2-1/2"	88.9	115.5	49.0	73.02	46.0	46.0
4"X2-1/2"	114.30	124.5	59.0	73.02	46.0	46.0
4"X3"	114.30	130.0	59.0	88.9	49.0	49.0

**REDUCING RING**

ITEM NO.:S10

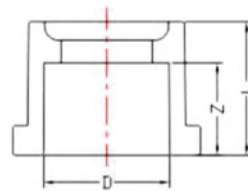

Size	Nom	D	L	Z
3/4"X1/2"	21.34	34.0	24.0	24.0
1"X3/4"	26.67	37.0	27.0	27.0
1-1/4"X1"	33.40	40.0	30.0	30.0
1-1/2"X1"	42.16	43.0	33.0	33.0
1-1/2"X1-1/4"	48.26	46.0	36.0	36.0
2"X1-1/2"	60.32	53.0	39.0	39.0
2-1/2"X2"	73.02	61.0	46.0	46.0
4"X3"	88.90	66.0	49.0	49.0

**MALE ELBOW 90°**

ITEM NO.:S19

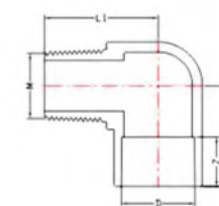

Size	Nom	D	L	Z	L1	M
1/2"	29.7	36.4	24.0	36.0	1/2"	1/2"
3/4"	35.4	42.7	27.0	42.0	3/4"	3/4"
1"	43.2	49.1	30.0	49.0	1"	1"

**FEMALE ADAPTER**

ITEM NO.:S25

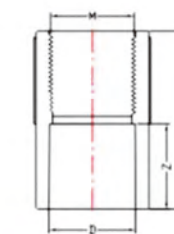

Size	Nom	D	L	Z	M
1/2"	21.34	50.5	24.0	1/2"	1/2"
3/4"	26.67	56.5	27.0	3/4"	3/4"
1"	33.40	62.5	30.0	1"	1"
1-1/4"	42.16	68.5	33.0	1-1/4"	1-1/4"
1-1/2"	48.26	74.5	36.0	1-1/2"	1-1/2"
2"	60.32	80.5	39.0	2"	2"
2-1/2"	73.02	97.0	46.0	2-1/2"	2-1/2"
3"	88.90	103.0	49.0	3"	3"
4"	114.30	123.0	59.0	4"	4"

**END CAP**

ITEM NO.:S12

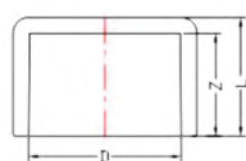

Size	Nom	D	L	Z
1/2"	21.34	34.0	24.0	24.0
3/4"	26.67	37.0	27.0	27.0
1"	33.40	40.0	30.0	30.0
1-1/4"	42.16	43.0	33.0	33.0
1-1/2"	48.26	46.0	36.0	36.0
2"	60.32	53.0	39.0	39.0
2-1/2"	73.02	61.0	46.0	46.0
3"	88.90	66.0	49.0	49.0
4"	114.30	67.5	59.0	59.0

**UNION**

ITEM NO.:S14

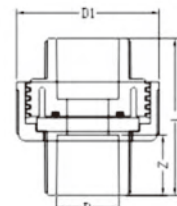

Size	Nom	D	L	Z	D1
1/2"	21.34	54.0	24.0	48.5	48.5
3/4"	26.67	60.0	27.0	56.2	56.2
1"	33.40	68.0	30.0	64.0	64.0
1-1/4"	42.16	76.0	33.0	75.7	75.7
1-1/2"	48.26	84.0	36.0	83.4	83.4
2"	60.32	93.0	39.0	98.3	98.3

**MALE ADAPTER**

ITEM NO.:S27

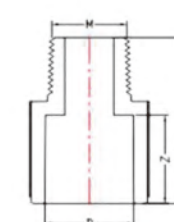

Size	Nom	D	L	Z	M
1/2"	21.34	43.5	24.0	1/2"	1/2"
3/4"	26.67	53.0	27.0	3/4"	3/4"
1"	33.40	58.5	30.0	1"	1"
1-1/4"	42.16	64.0	33.0	1-1/4"	1-1/4"
1-1/2"	48.26	69.0	36.0	1-1/2"	1-1/2"
2"	60.32	75.5	39.0	2"	2"
2-1/2"	73.02	93.5	46.0	2-1/2"	2-1/2"
3"	88.90	99.5	49.0	3"	3"
4"	114.30	113.5	59.0	4"	4"

**FEMALE TEE**

ITEM NO.:S31



Size	Nom	D	L	Z	L1	M
3/4"X1/2"	29.7	36.5	24.0	36.5	1/2"	1/2"
1"X1/2"	35.4	42.0	27.0	42.0	3/4"	3/4"
1"X3/4"	43.2	48.0	30.0	48.0	1"	1"

**FEMALE ELBOW**

ITEM NO.:S16

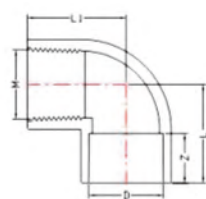

Size	Nom	D	L	Z	D1	M
1/2"	29.7	36.4	24.0	36.4	1/2"	1/2"
3/4"	35.4	42.7	27.0	42.7	3/4"	3/4"
1"	43.2	49.1	30.0	49.1	1"	1"

**REDUCING ELBOW (THREADED)**

ITEM NO.:S17

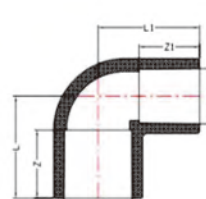

Size	Nom	D	L	Z	D1	L1	Z1
3/4"X1/2"	26.67	40.0	27.0	21.34	40.0	24.0	24.0
1"X1/2"	33.40	42.5	30.0	21.34	42.5	24.0	24.0
1"X3/4"	33.40	45.5	30.0	26.67	45.5	27.0	27.0

**FEMALE CAP**

ITEM NO.:S32

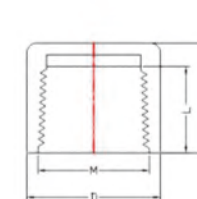

Size	Nom	D	L	Z	M
1/2"	29.7	30.5	24.0	1/2"	1/2"
3/4"	35.4	33.5	27.0	3/4"	3/4"
1"	43.2	37.0	30.0	1"	1"

**MALE COUPLING**

ITEM NO.:S35

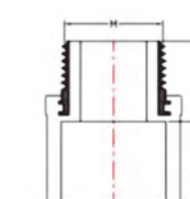

Size	Nom	D	L	Z	M
1/2"	21.34	45.0	24.0	1/2"	1/2"
3/4"	26.67	51.0	27.0	3/4"	3/4"
1"	33.40	53.0	30.0	1"	1"
1-1/4"	42.16	62.0	33.0	1-1/4"	1-1/4"
1-1/2"	48.26	66.0	36.0	1-1/2"	1-1/2"
2"	60.32	74.0	39.0	2"	2"

**FEMALE COUPLING  
(COPPER THREAD)**

ITEM NO.:S36

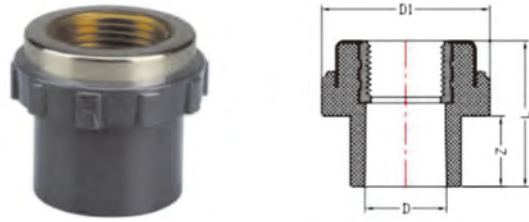

Size	Nom	D	L	Z	M
1/2"x1/2"	21.34	19.0	24.0	45.0	
1/2"x3/4"	21.34	19.0	24.0	45.0	
3/4"x3/4"	26.67	21.0	27.0	45.0	
3/4"x1/2"	26.67	21.0	27.0	45.0	
1"x1"	33.40	26.0	30.0	49.5	
1"x3/4"	33.40	26.0	30.0	49.5	

**90DEG FEMALE ELBOW  
(COPPER THREAD)**

ITEM NO.:S37



Size	Nom	D	L	Z	D1	L1
1/2"x1/2"	21.34	29.0	24.0	42.5	28.0	
1/2"x3/4"	21.34	29.0	27.0	42.5	28.0	
3/4"x3/4"	26.67	31.0	30.0	42.5	29.5	
3/4"x1/2"	26.67	31.0	33.0	42.5	29.5	

**FEMALE TEE  
(COPPER THREAD)**

ITEM NO.:S38

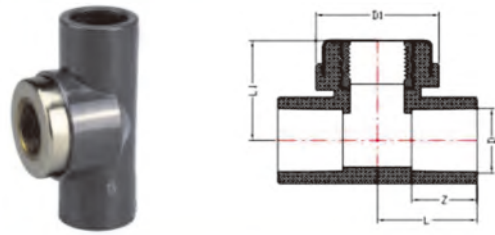

Size	Nom	D	L	Z	D1	L1
1/2"x1/2"	21.34	34.0	24.0	42.5	34.0	
1/2"x3/4"	21.34	34.0	24.0	42.5	34.0	
3/4"x3/4"	26.67	37.0	27.0	42.5	36.5	
3/4"x1/2"	26.67	37.0	27.0	42.5	36.5	



**PVC DWV PIPE & FITTINGS(ASTM D2665)**



DWV PVC PIPE

ITEM NO.:OGZ01



Size	1-1/4"	1-1/2"	2"	3"	4"	6"	8"
------	--------	--------	----	----	----	----	----

DWV 90DEG ELBOW (II)

ITEM NO.:D02

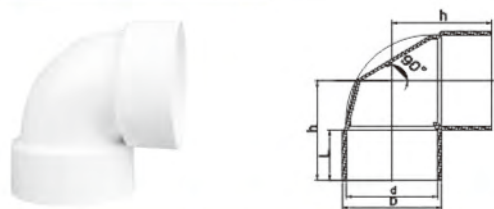

Size	Nom	d	D	L	h
2"	60.32	66.2	24	65.3	
3"	88.9	93.0	40.8	91.0	
4"	114.3	118.7	43.5	104.2	

DWV 90DEG TEE (II)

ITEM NO.:D04



Size	Nom	d	D	L	H
2"	65.11	60.11	115.5	19.05	
3"	88.9	93.0	40.8	178.2	
4"	114.3	118.7	43.5	208.5	

DWV BEND

ITEM NO.:D06

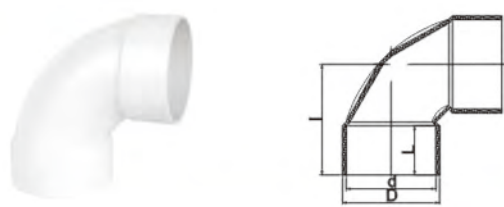

Size	Nom	d	D	L	I
1-1/2"	48.26	55.5	19.0	52.8	
2"	60.32	66.2	23.4	65.3	
3"	88.90	94.2	38.8	116.8	
4"	114.30	120.4	46.1	138.8	
6"	168.28	176.1	75.8	177.9	

DWV COUPLER

ITEM NO.:D01



Size	Nom	d	D	L	H
1-1/2"	48.26	56.8	17.6	40.0	
2"	60.32	68.8	19.2	44.0	
3"	88.90	100.7	38.2	82.6	
4"	114.30	127.7	44.6	95.8	
6"	168.28	183.3	76.5	159.0	

DWV 45 DEG ELBOW

ITEM NO.:D03



Size	Nom	d	D	h	L
1-1/2"	48.26	56.8	35.3	17.6	
2"	60.32	68.8	39.4	19.2	
3"	88.9	100.7	66.6	38.2	
4"	114.3	127.7	79.3	44.6	
6"	168.28	183.3	125	76.5	

DWV TEE

ITEM NO.:D05



Size	Nom	d	D	L	H	h
1-1/2"	48.26	56.8	17.6	109.3	63.2	
2"	60.32	68.8	19.2	130.0	75.0	
3"	88.90	100.7	38.2	199.8	115.0	
4"	114.30	127.7	44.6	247.0	139.5	
6"	168.28	183.3	76.5	380.0	205.0	

DWV Y-TEE

ITEM NO.:D07



Size	Nom	d	D	L	h	H
1-1/2"	48.26	56.8	17.6	90.8	138.8	
2"	60.32	68.8	19.2	109.3	165.8	
3"	88.9	100.7	38.2	165.2	241	
4"	114.3	127.7	44.6	205.4	298.4	
6"	168.28	183.3	76.5	306	443	

DWV PLUG

ITEM NO.:D10



Size	Nom	d	d1	D	NPT	L	H
1-1/4"	42.16	38	47.3	1-1/4"	15.5	38.6	
1-1/2"	48.26	40	56.8	1-1/2"	17.7	41.5	
2"	60.32	52	68.8	2"	19.3	45.5	
3"	88.9	77.4	100.7	3"	38.3	73.5	
4"	114.3	101.2	127.7	4"	44.7	82.8	
6"	168.28	156	247.2	6"	75	120	

DWV TRIPLE

ITEM NO.:D12

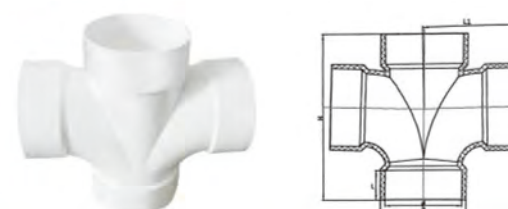

Size	Nom	d	d1	D	L	H
4"	114.3	127.7	44.6	137.7	247	

DWV END CAP

ITEM NO.:D14

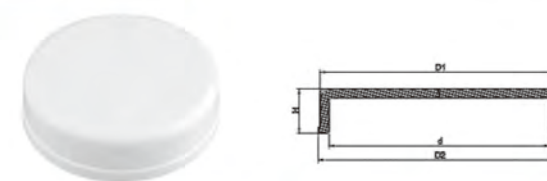

Size	Nom	d	D1	D2	H
2"	60.32	64.1	66.3	23.5	
3"	88.90	92.4	94.3	25.6	
4"	114.30	120.2	122.5	28.3	
6"	168.8	173.8	173.8	50	

S-TRAP WITHOUT CLEAN OUT

ITEM NO.:D16

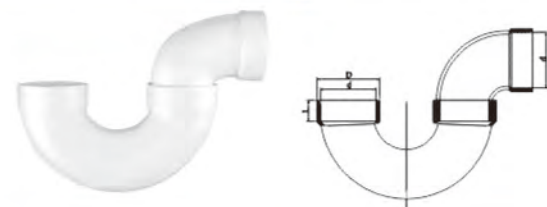

Size	Nom	d	D	L
1-1/2"	48.26	54.2	18.5	
2"	60.32	69.0	25.0	

DWV VENT CAP

ITEM NO.:D11



Size	Nom	d	d1	D	L	H
2"	60.32	29.0	67.8	19.2	72.0	
3"	88.90	45.0	96.4	38.2	93.9	
4"	114.30	84.0	120.8	32.5	102.0	

DWV MALE ADAPTER

ITEM NO.:D13



Size	Nom	d	d1	D	L	H
2"	60.32	50.2	69	23.2	47.5	

DWV REDUCING BUSHING

ITEM NO.:D15



Size	Nom	d	D	L	H
2" x 1-1/2"	48.26	68.8	17.4	32.5	
4" x 2"	60.32	114.7	23.1	49.2	
3" x 2"	60.32	89.4	19.6	40.6	
4" x 3"	88.90	114.7	34.5	51.5	

S-TRAP WITH MALE CLEAN OUT

ITEM NO.:D17



Size	Nom	d	D	L
1-1/2"	48.26	54.2	18.5	
2"	60.32	69.0	25.0	

**DWV U-ELBOW** ITEM NO.:D18

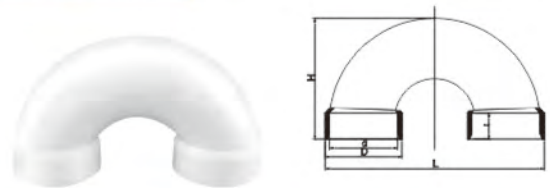

Size	Nom	d	D	I	L	H
1-1/2"	48.26	54.2	18.5	156.1	85.2	
2"	60.32	69.0	25.0	194.9	106.3	

**DWV TRAP WITH UNION** ITEM NO.:D20



Size	Nom	d	D	L
1-1/2"	48.26	54.2	18.5	

**TRAP** ITEM NO.:D22



Size	Nom	d	D1	NPT	L1	L2
1-1/2"	48.26	57.6	1-1/2"	18.2	19.8	

**DWV REDUCING Y-TEE** ITEM NO.:D25



Size	Nom	d	d1	D	D1	L1	L2
4" x 2"	114.3	60.3	121.5	66.3	47	21.5	

**FLOOR DRAIN** ITEM NO.:D30

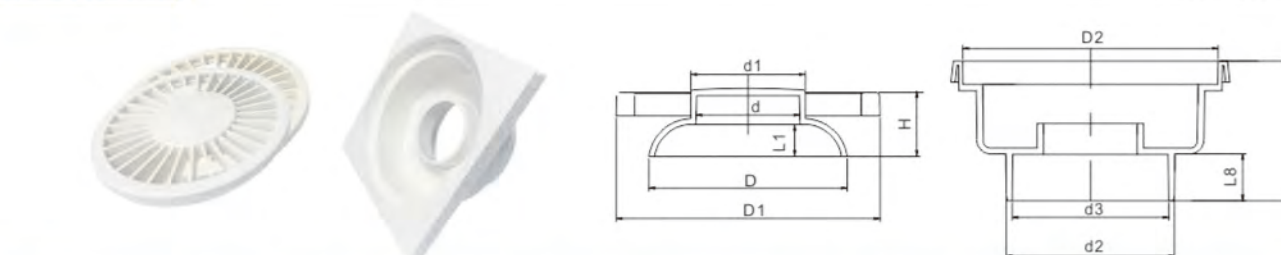

Size	Nom	d	d1	D	D1	L	H	d2	d3	D2	L1	H1
2"	35.9	39.7	68.6	91.3	8	22	60.34	56.2	91.6	16.7	50	

**DWV ELBOW M\*F** ITEM NO.:D19



Size	Nom	d1	D1	L	d2	D2
1-1/2"	48.26	54.2	18.5	41.9	48.0	
2"	60.32	69.0	25.0	56.0	60.3	

**TAIL PIECE** ITEM NO.:D21

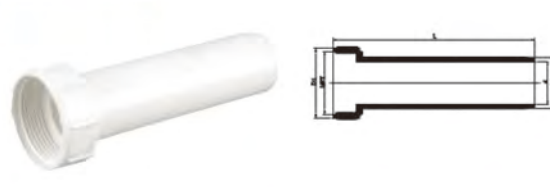

Size	Nom	NPT	D1	L	d	D2
1-1/2"	1-1/2"	53.5	154.7	33.2	37.8	
1-1/4"	1-1/4"					

**S-TRAP WITH FEMALE CLEAN OUT** ITEM NO.:D23



Size	Nom	d	D	L
1-1/2"	48.26	54.2	18.5	
2"	60.32	69.0	25.0	

**DWV REDUCING TEE** ITEM NO.:D28

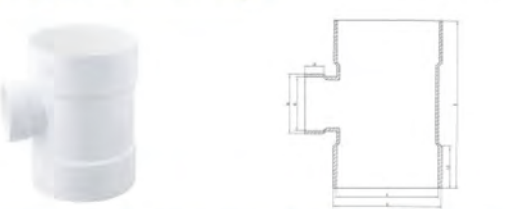

Size	Nom	d	d1	D	D1	L1	L2	H
4" x 2"	114.3	60.3	121.5	66.3	47	21	189	

**DWV COUPLER (III)** ITEM NO.:D01



Size	Nom	L	D	D1	D2
1-1/2"	17.4	56.56	48.64	48.11	
2"	19.1	68.63	60.71	60.17	
3"	38.1	100.53	89.41	88.7	
4"	44.45	127.5	114.8	114.1	

**DWV 90DEG ELBOW (III)** ITEM NO.:D06



Size	Nom	L	D	D1	D2	L1	L2
1-1/2"	17.5	56.56	48.64	48.11	44	44	
2"	19.1	68.63	60.71	60.17	59	59	
3"	38.1	100.53	89.41	88.7	78	78	
4"	44.5	127.5	114.8	114.1	98	98	

**DWV TEE(III)** ITEM NO.:D09



Size	Nom	L	D	D1	D2	L1	L2	L3
1-1/2"	17.4	56.56	48.64	48.11	44	25	44	
2"	19.1	68.63	60.71	60.17	59	35	59	
3"	38.1	100.53	89.41	88.7	78	46	78	
4"	44.45	127.5	114.8	114.1	98	57	98	

**DWV TRIPLE(III)** ITEM NO.:D12



Size	Nom	D	D1	D2	L	L1	L2	L3
2"	68.63	60.71	60.17	19.1	59	35	59	
3"	100.53	89.41	88.7	38.1	78	46	78	
4"	127.5	114.8	114.1	44.5	98	57	98	

**DWV 45 DEG ELBOW (III)** ITEM NO.:D03



Size	Nom	L	D	D1	D2	L1
1-1/2"	17.44	56.56	48.64	48.11	48.11	
2"	19.1	68.63	60.71	60.17	60.17	
3"	38.1	100.53	89.41	88.7	88.7	
4"	44.5	127.5	114.8	114.1	114.1	

**DWV Y-TEE(III)** ITEM NO.:D08



Size	Nom	L	D	D1	D2	L1	L2	L3
1-1/2"	17.5	56.56	48.64	48.11	73	29	73	
2"	19.1	68.63	60.71	60.17	92	35	92	
3"	38.1	100.53	89.41	88.7	127	41	127	
4"	44.5	127.5	114.8	114.1	162	48	162	

**DWV PLUG(III)** ITEM NO.:D10



Size	Nom	NPT	D	D1	D2	D3	L	L1	L2	L3	L4	L5
1-1/4"	1-1/4"	42.16	35	48	34.2	13.5	17	34	9	13	23	
1-1/2"	1-1/2"	48.26	40.9	55	40.3	15.5	20	38	11	15	25	
2"	2"	127.5	52.5	68	52.3	16	20	40	11.5	15.5	30.5	
3"	3"	88.9	77.9	100	78	20.5	27	65	14.5	20	40	
4"	4"	114.3	102.26	125	101.6	22	28	72	15.5	21.5	46.5	

**DWV REDUCING BUSHING(III)** ITEM NO.:D13



Size	Nom	NPT	D	D1	D2	D3	L	L1	L2
1-1/2"x1-1/4"	1-1/4"	56.56	48.64	48.11	33	17.93	20.1	49.64	
2"	2"	68.63	60.71	60.17	48	19.1	20.1	51.27	
4"	4"	127.5	114.8	114.1	98	44.5	48.9	99.55	

DWV REDUCING BUSHING(III) ITEM NO.:D15

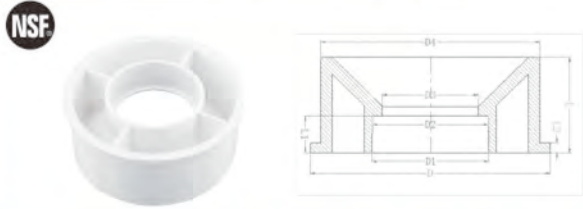

Size	Nom	D	D1	D2	D3	D4	L	L1	L2
2"x1-1/2"	65	48.64	48.11	40	60.32	24.1	17.5	5	
3"x2"	95	60.71	60.17	55	88.9	43.1	19.1	5	
4"x2"	125	60.71	60.17	50	114.3	49.5	19.1	5	
4"x3"	125	89.41	88.7	80	114.3	49.5	38.1	5	
6"x4"									

S-TRAP WITH MALE CLEAN OUT(III) ITEM NO.:D17

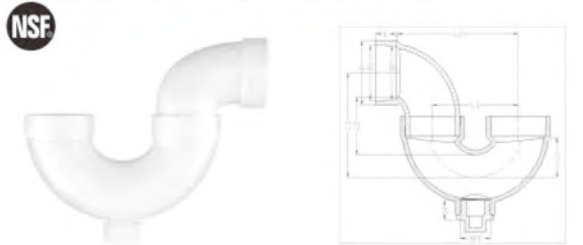

Size	Nom	NPT	D	D1	D2	L	L1	L2	L3	L4	L5	L6
1-1/2"	1-1/2"	56.64	48.64	48.11	17.5	92	50.8	107	76	35	17	
2"	2"	68.71	60.71	60.17	19.1	116	65	184	127	57	17	

DWV ELBOW M\*F(III) ITEM NO.:D19

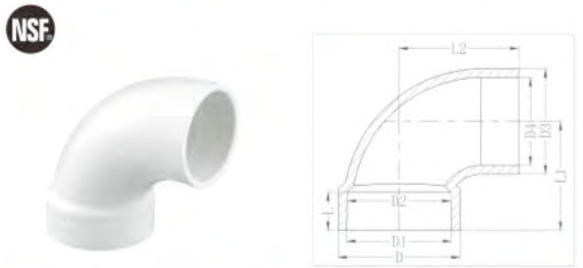

Size	Nom	D	D1	D2	D3	D4	L	L1	L2
1-1/2"	56.64	48.64	48.11	48.26	20.46	17.5	35	77.94	
2"	68.71	60.71	60.17	60.32	52.32	19.1	116	106.91	

PVC FLANGE ITEM NO.:D24



Size	Nom	d	d2	D	D1	L1	L2
4**3"	89.2	100	176	146	59.5	11	
4"	114	127.5	180	152	45.5	10	

S-TRAP WITHOUT CLEAN OUT(III) ITEM NO.:D16



Size	Nom	D	D1	D2	L	L1	L2	L3	L4	L5
1-1/2"	56.64	48.64	48.11	17.5	92	50.8	107	76	35	
2"	68.71	60.71	60.17	19.1	116	65	184	127	57	

DWV U-ELBOW(III) ITEM NO.:D18



Size	Nom	D	D1	D2	L	L1	L2	L3
1-1/2"	56.64	48.64	48.11	17.5	35	77.94	76	
2"	68.71	60.71	60.17	19.1	116	106.91	127	

S-TRAP WITH FEMALE CLEAN OUT(III) ITEM NO.:D23

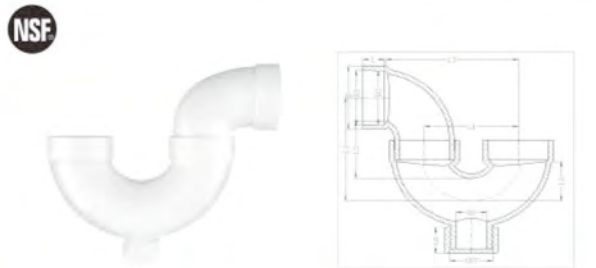

Size	Nom	NPT	D	D1	D2	L	L1	L2	L3	L4	L5	L6
1-1/2"	1-1/2"	56.64	48.64	48.11	17.5	92	50.8	107	76	35	22.8	
2"	2"	68.71	60.71	60.17	19.1	116	65	184	127	57	22.8	

DWV REDUCING Y-TEE (III) ITEM NO.:D25



Size	Nom	L	D	D1	D2	D3	D4	D5	L1	L2	L3	L4
2*1-1/2	19.1	68.63	60.71	60.17	56.56	48.64	48.11	17.4	84	27	87	
4*2	44.5	127.5	114.8	114.1	68.63	60.71	60.17	19.1	119	10	141	
4*3	44.5	127.5	114.8	114.1	100.53	89.41	88.7	38.1	141	27	152	

DWV REDUCING TEE(III) ITEM NO.:D28



Size	Nom	L	D	D1	D2	D3	D4	D5	L1	L2	L3	L4
3*1-1/2"	38.1	100.53	89.41	88.7	56.56	48.64	48.11	65	24	44	17.44	
3*2"	38.1	100.53	89.41	88.7	68.63	60.71	60.17	73	30	54	19.1	
4*2"	44.5	127.5	114.8	114.1	68.63	60.71	60.17	84	29	52	19.1	
4*3"	44.5	127.5	114.8	114.1	100.53	89.41	88.7	90	44	76	38.1	

90 ELBOW WITH LOW HEEL ITEM NO.:D31

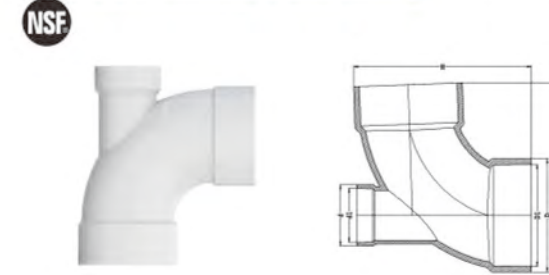

Size	Nom	L	H	D	D1	d1	d2
3**1-1/2"	172	168	100.5	89.41	56.6	48.64	
3**2"	172	168	100.5	89.41	68.6	60.71	
4**2"	213	208	127.5	114.8	68.6	60.71	

2 WAY CLEANOUT TEE ITEM NO.:D32

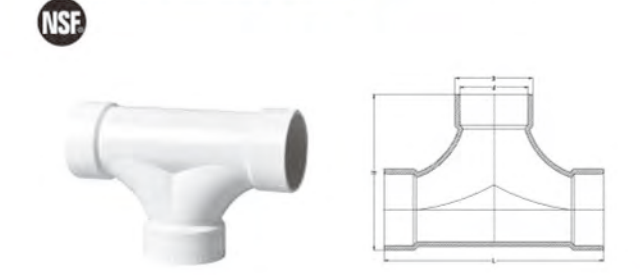

Size	Nom	L	H	D	d
3"	286	193	100.5	89.41	
4"	344	236	127.5	114.8	

PVC 90 CLOSET ELBOW ITEM NO.:D33

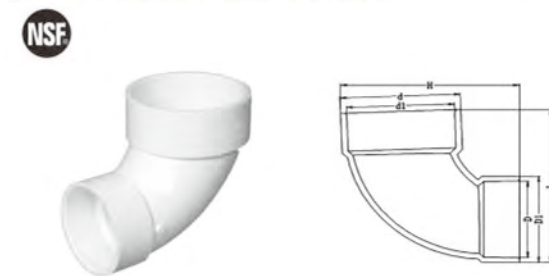

Size	Nom	L	H	D	D1	d1	d2
4**3"	178.4	189.8	100.5	127.5	127.5	114.8	

PVC DOUBLE WYE ITEM NO.:D34

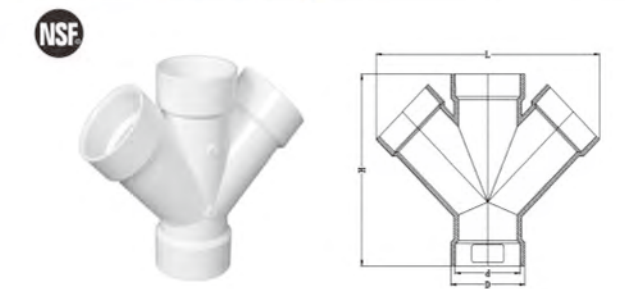

Size	Nom	L	H	D	d
2"	208	169	68.63	60.71	
3"	307	248	100.53	89.41	
4"	384	302	127.5	114.8	

**PVC TEST TEE WITH PLUG** ITEM NO.:D35

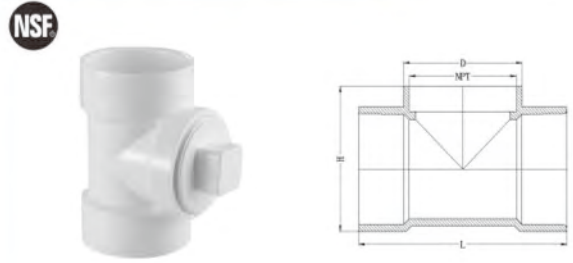

Size	Nom	L	H	D	HPT
1-1/2"	98	74	55	1-1/2"	1-1/2"
2"	117	88	69	2"	2"
3"	176	117	100	3"	3"
4"	222	150	128	4"	4"

**PVC MALE PLUG** ITEM NO.:D37

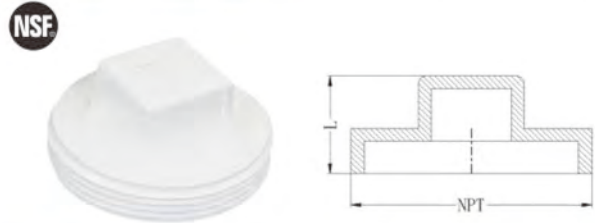

Size	Nom	NPT	L
1-1/2"	1-1/2"	25.5	
2"	2"	31	
3"	3"	40.5	
4"	4"	46.5	

**PVC CHECK TEE** ITEM NO.:D42

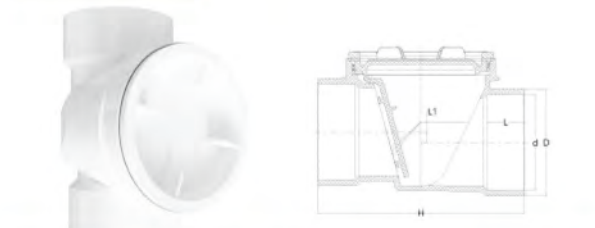

Size	Nom	d	D	L	L1	H
2"	60.71	68.71	20	7.5	115	
3"	89.41	100.53	38.1	9.8	188	
4"	114.8	127.5	44.45	12.5	246.2	
6"	168.8	183.08	76.2	19	381.3	

**PVC H-TYPE FOUR-WAY** ITEM NO.:D44



Size	Nom	d	D	L	L1	H
4"	114.8	119.6	45	180	291	

**PVC TEST TEE(FMEALE)** ITEM NO.:D36



Size	Nom	NPT	D	L	H
1-1/2"	1-1/2"	55	98	74	
2"	2"	68.6	117	88	
3"	3"	100	176	117	
4"	4"	127.5	150	222	

**PVC CLOSET FLANGE** ITEM NO.:D41



Size	Nom	d	D	L	H
4"3"	89.41	100.67	35.8	80.83	

**PVC SEWER BACKFLOW PREVENTER** ITEM NO.:D43



Size	Nom	d	D	L	H
2"	60.71	65.2	19.05	72.51	
3"	89.41	95.5	38.1	115.35	
4"	114.8	122.1	44.45	140.44	
6"	168.8	176	76.2	206.76	

**PVC EXPANSION PIPE** ITEM NO.:D45

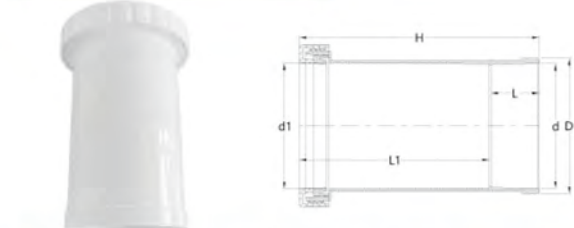

Size	Nom	d	d1	D	L	L1	H
4"	114.8	115.9	124.8	44.45	175	220	

**PVC PRESSURE PIPE & FITTINGS(NBR5648)**



**COUPLING**

ITEM NO.:BN01

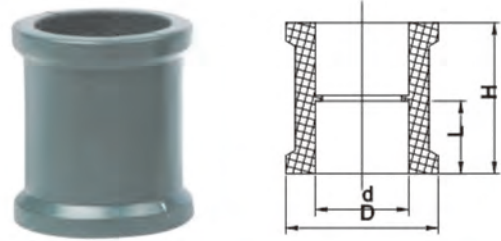

Size	Nom	D	d	L	H
20	28.5	20	16.5	35.0	
25	34.0	25	18.5	40.3	
32	43.0	32	22.5	47.6	
40	51.5	40	26.2	55.5	
50	63.0	50	31.3	65.7	
63	80.0	63	37.5	79.0	
75	95.6	75	44.2	93.0	
85	111.0	85	50.0	108.2	
90	120.4	90	55.7	123.4	
110	130.6	110	61.1	131.0	

**EQUAL TEE**

ITEM NO.:BN02

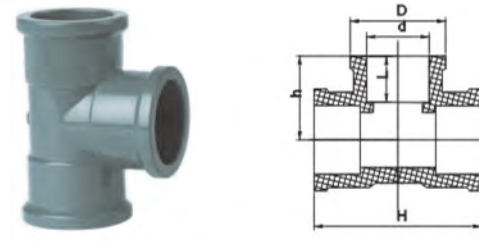

Size	Nom	D	d	L	h	H
20	28.5	20	16.5	28.0	54.2	
25	34.0	25	18.5	31.8	64.0	
32	43.0	32	22.5	40.0	78.2	
40	51.5	40	26.2	47.1	95.0	
50	63.0	50	31.3	58.0	115.0	
63	80.0	63	37.5	70.0	140.0	
75	95.6	75	44.2	82.5	163.4	
85	111.0	85	50.0	95.2	190.2	
90	120.4	90	55.7	108.0	216.5	
110	130.6	110	61.1	122.7	246.0	

**REDUCING TEE**

ITEM NO.:BN03

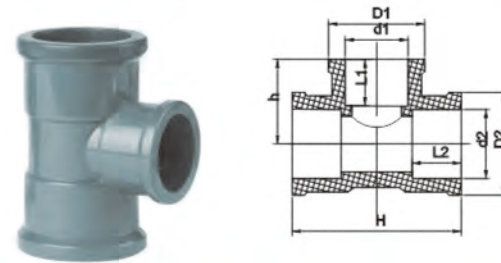

Size	Nom	D1	d1	D2	d2	L1	L2	h	H
25x20	28.5	20.0	34.0	25.0	16.5	18.5	29.6	59.2	
32x25	34.0	25.0	43.0	32.0	18.5	22.5	35.5	71.6	
40x32	43.0	32.0	51.5	40.0	22.5	26.2	44.0	86.5	

**FEMALE SOCKET**

ITEM NO.:BN04

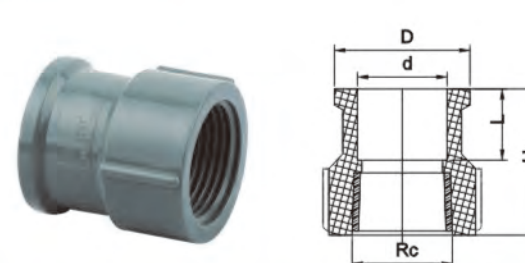

Size	Nom	D	d	Rc	L	H
20x1/2"	28.5	20	1/2"	16.5	36.2	
25x1/2"	33.3	25	1/2"	18.5	41.3	
25x3/4"	34.0	25	3/4"	18.5	40.2	
32x1"	43.0	32	1"	22.5	47.2	
40x1-1/4"	51.5	40	1-1/4"	26.2	55.0	
50x1-1/2"	62.0	50	1-1/2"	31.3	57.5	
63x2"	80.0	63	2"	37.5	62.3	

**MALE ADAPTER**

ITEM NO.:BN05

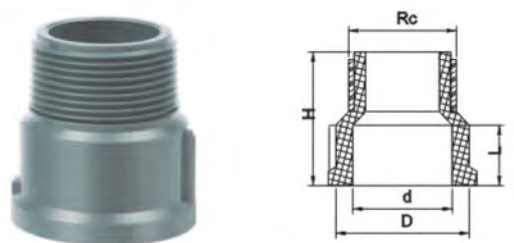

Size	Nom	D	d	Rc	L	H
20x1/2"	28.5	20	1/2"	16.5	38.0	
25x3/4"	34.0	25	3/4"	18.5	42.0	
32x1"	43.0	32	1"	22.5	49.5	
40x1-1/4"	51.5	40	1-1/4"	26.2	56.0	
50x1-1/2"	63.0	50	1-1/2"	31.3	65.7	
63x2"	80.0	63	2"	37.5	78.6	
75x2-1/2"	95.6	75	2-1/2"	44.2	91.3	
85x3"	111.0	85	3"	50.0	105.5	
90x3"	120.4	90	3"	55.7	122.4	
110x4"	130.6	110	4"	61.1	134.2	

**90 DEG ELBOW**

ITEM NO.:BN06

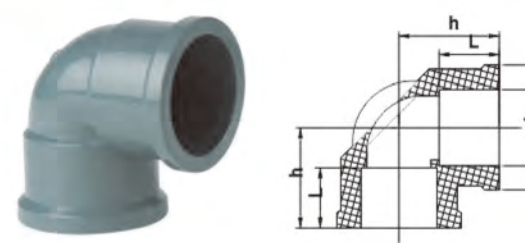

Size	Nom	D	d	L	h
20	28.5	20	16.5	27.4	
25	34.0	25	18.5	32.0	
32	43.0	32	22.5	39.3	
40	51.5	40	26.2	47.8	
50	63.0	50	31.3	58.5	
63	80.0	63	37.5	70.5	
75	95.6	75	44.2	82.5	
85	111.0	85	50.0	95.2	
90	120.4	90	55.7	108.0	
110	130.6	110	61.1	123.3	

**FEMALE ELBOW**

ITEM NO.:BN07

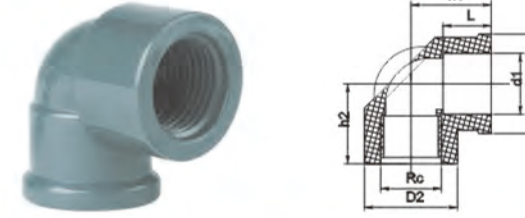

Size	Nom	D1	d1	D2	Rc	L	h1	h2
20x1/2"	28.5	20.0	30.2	1/2"	16.5	26.4	28.5	
25x3/4"	34.0	25.0	36.6	3/4"	18.5	33.0	32.0	
25x1/2"	34.0	25.0	30.2	1/2"	17.8	32.6	31.0	
32x1"	43.0	32.0	44.0	1"	22.5	39.4	39.5	

**REDUCING ELBOW**

ITEM NO.:BN09

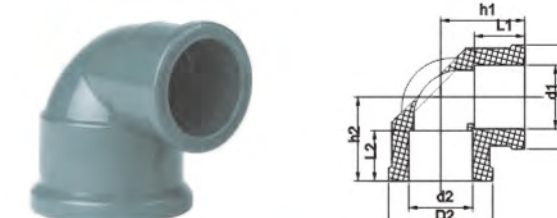

Size	Nom	D1	d1	D2	d2	L1	L2	h1	h2
25x20	28.5	20.0	34.0	25.0	16.5	18.5	30.0	29.8	
32x25	34.0	25.0	43.0	32.0	18.5	22.5	36.1	35.7	
40x25	34.0	25.0	52.0	40.0	18.5	26.2	38.7	41.1	
40x32	43.0	32.0	52.0	40.0	22.5	26.2	44.8	44.0	

**TANK ADAPTER**

ITEM NO.:BN11

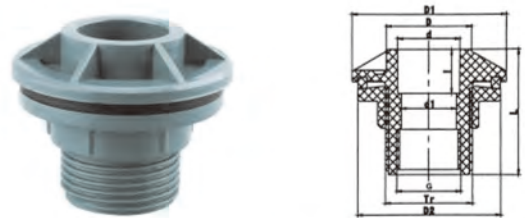

Size	Nom	d	d1	D	D1	G	Tr	D2	I	L
20x1/2"	20	17.6	28.5	63	1/2"	32.4	58	15.2	60	
25x3/4"	25	22.3	34	71.2	3/4"	38.2	65.4	18.6	60	
32x1"	32	28.6	44	79.5	1"	45	73.8	22.5	64	
40x1-1/4"	40	35	54.8	87.6	1-1/4"	53	82	26.2	64	
50x1-1/2"	50	43	61	95	1-1/2"	57.8	87.5	36.3	67.2	
63x2"	63	54.4	74.8	109	2"	73	102	37.5	67.5	

**REDUCING COUPLING**

ITEM NO.:BN08

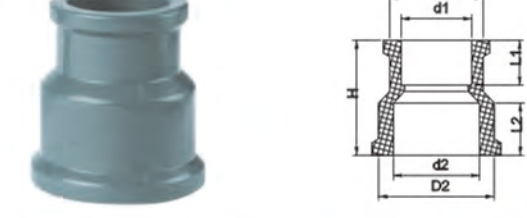

Size	Nom	D1	d1	D2	d2	L1	L2	H
25x20	28.5	20.0	34.0	25.0	16.5	18.5	40.0	
32x25	34.0	25.0	43.0	32.0	18.5	22.5	47.6	
40x32	43.0	32.0	51.5	40.0	22.5	26.2	56.0	

**UNION**

ITEM NO.:BN10

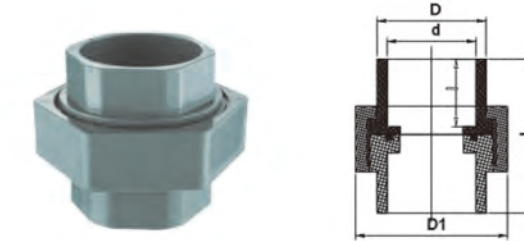

Size	Nom	D	d	D1	I	L
20	30.2	20.0	48.0	16.5	45.5	
25	36.8	25.0	55.0	18.5	51.5	
32	38.0	32.0	55.0	22.5	54.2	
40	52.0	40.0	76.0	26.2	68.2	
50	59.0	50.0	85.0	31.3	74.3	
63	72.8	63.0	101.0	37.5	85.2	

**REDUCING RING**

ITEM NO.:BN12

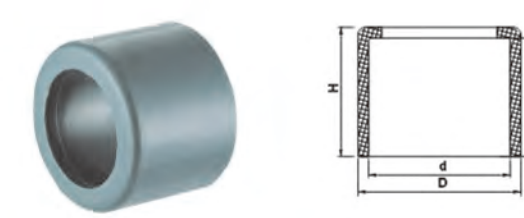

Size	Nom	D	d	L	H
25x20	25.0	20.0	16.5	18.7	
32x25	32.0	25.0	18.5	22.2	
40x32	40.0	32.0	22.5	26.2	
40x50	50.0	40.0	26.2	31.6	
63x50	63.0	50.0	31.3	37.9	

**END CAP**

ITEM NO.:BN13

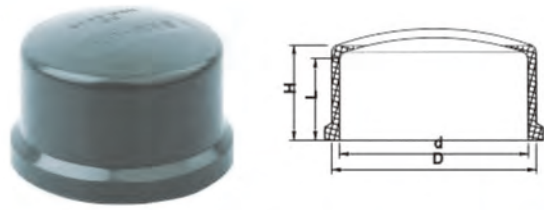

Size	Nom	D	d	L	H
20	28.5	20.0	16.5	21.5	
25	34	25.0	18.5	25.0	
32	43.0	32.0	22.5	29.0	
40	51.5	40.0	26.2	33.0	
50	63.0	50.0	31.3	39.2	
63	80.0	63.0	37.5	47.7	
75	95.6	75.0	44.2	56.5	
85	111.0	85.0	50.0	66.2	
90	120.4	90.0	55.7	78.4	
110	130.6	110.0	61.1	90.5	

**45 DEG ELBOW**

ITEM NO.:BN14



Size	Nom	d	D	L	h
20	20.0	27	16.5	21.5	
25	25.0	33.0	19.5	25.5	
32	32.0	41.3	22.5	30.0	
40	40.0	50.4	26.5	36.0	
50	50.0	61.0	31.5	43.5	
63	63.0	75.9	38.5	53.5	

**FEMALE SOCKET WITH BRASS**

ITEM NO.:BN15

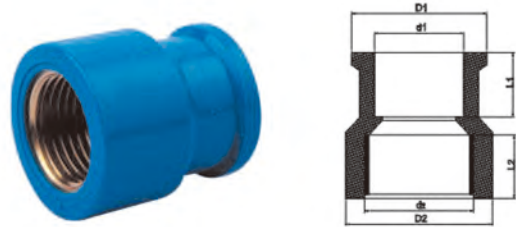

Size	Nom	d1	D1	d2	D2	L1	L2
20x1/2"	20	28.5	1/2"	30.2	18.5	16.5	
25x3/4"	25	34.0	3/4"	36.6	22.5	18.5	
32x1"	32	43.0	1"	44	26.2	22.5	

**FEMALE TEE WITH BRASS**

ITEM NO.:BN16

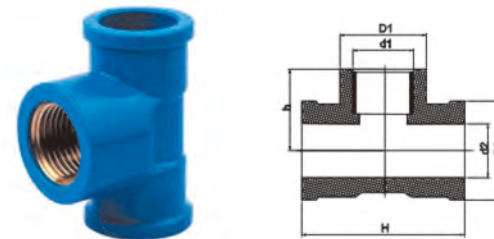

Size	Nom	d1	D1	d2	D2	h	H
20x1/2"	1/2"	30.2	20	28.5	28.0	54.2	
25x3/4"	3/4"	36.6	25	34.0	31.8	64.0	
32x1"	1"	44	32	43.0	40.0	78.2	

**PP BACKNUT**

ITEM NO.:ZX901



Size	Nom	R1	R2	L	h1	h2	h3
32	32.0	62.4	68.4	8.6	12.0	5.6	

**PVC VENT CAP**

ITEM NO.:ZX903



Size	Nom	d	d1	D	H	L
50	50	21	63	72	31.3	
75	75	45	95.6	93.2	44.2	
110	110	84	130.6	102.4	61.1	

# PVC DWV FITTINGS WITH SOCKET(NBR5688)



REDUCING TEE WITH SOCKET

ITEM NO.:G01

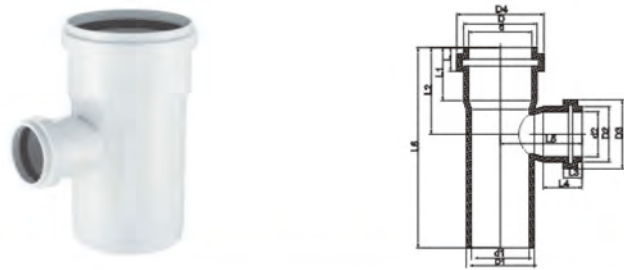

Size	Nom	d	d1	d2	D	D1	D2	D3	D4	L	L1	L2	L3	L4	L5	L6
75x50		76.0	69.0	50.5	82.0	75.0	56.2	92.0	66.0	18.9	44.0	83.3	18.4	43.0	86.9	157.0
110x50		111.0	103.6	50.5	117.4	110.0	56.5	127.6	66.0	21.0	51.0	91.8	18.4	43.0	104.4	178.0
110x75		111.0	103.6	76.0	117.4	110.0	82.0	127.6	92.0	21.0	51.0	104.3	18.9	44.0	113.3	203.0
160x110		161.0	152.8	111.0	168.2	160.0	117.4	180.8	127.6	26.5	66.0	139.4	21.0	51.0	146.8	274.0

ELBOW WITH SOCKET

ITEM NO.:G02

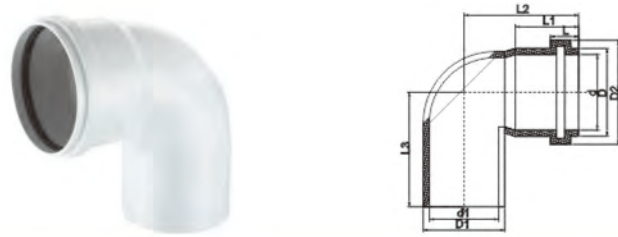

Size	Nom	d	d1	D	D1	D2	L	L1	L2	L3
40		41.0	35.5	45.1	39.9	53.8	17.2	36.5	57.6	48.2
50		50.5	44.0	56.5	50.0	66.0	18.4	38.0	72.2	66.9
75		76.0	69.0	82.0	75.0	92.0	18.9	44.0	92.5	85.9
110		111.0	103.0	118.0	110.0	128.2	24.0	71.8	144.4	136.6
160		161.0	152.8	168.2	160.0	180.8	26.5	66.0	157.2	159.6

TEE WITH SOCKET

ITEM NO.:G03



Size	Nom	d	d1	D	D1	D2	L	L1	L2	L3	L4
40		41.0	35.5	45.1	39.9	53.8	17.2	38.0	61.6	73.3	127.4
50		50.5	46.0	54.5	50.0	64.0	17.5	45.7	79.0	87.8	159.0
75		76.0	69.0	82.0	75.0	92.0	18.9	44.0	95.8	95.8	182.0
110		111.0	103.0	118.0	110.0	128.2	24.0	72.5	149.0	142.3	283.0
160		161.0	152.8	168.2	160.0	180.8	26.5	66.0	164.4	164.4	324.0

45DEG ELBOW WITH SOCKET

ITEM NO.:G04



Size	Nom	d	d1	D	D1	D2	L	L1	L2	L3
50		50.5	44.0	56.5	50.0	66.0	18.4	36.5	58.6	53.3
75		76.0	69.0	82.0	75.0	92.0	18.9	44.0	72.2	65.5
110		111.0	103.0	118.0	110.0	128.2	24.0	66.0	109.8	109.8
160		161.0	152.8	168.2	160.0	180.8	26.5	66.0	113.9	116.1

SKREW TEE WITH SOCKET

ITEM NO.:G05



Size	Nom	d	d1	D	D1	D2	L	L1	L2	L3	L4
50		50.5	44.0	56.5	50.0	66.0	18.4	36.5	105.1	105.1	159.0
75		76.0	69.0	82.0	75.0	92.0	18.9	44.0	143.4	143.4	209.0
110		111.0	103.0	118.0	110.0	128.2	24.0	72.5	215.4	215.4	318.5

SKREW CROSS WITH SOCKET

ITEM NO.:G06



Size	Nom	d	d1	D	D1	D2	L	L1	L2	L3	L4
110		111.0	103.0	118.0	110.0	128.2	24.0	72.5	215.4	215.4	318.5

REDUCING SKEW TEE WITH SOCKET

ITEM NO.:G07



Size	Nom	d	d1	d2	D	D1	D2	D3	D4	L	L1	L2	L3	L4	L5	L6
110x50		111.0	103.6	50.5	117.4	110.0	56.5	127.6	66.0	21.0	51.0	150.1	18.4	43.0	148.2	194.0

REDUCING COUPLING

ITEM NO.:G08



Size	Nom	d	d1	D	D1	D2	L	L1	L2	L3	H
110x50		50.5	103.6	56.5	110.0	66.0	18.4	36.5	63.0	30.0	132.0

# CPVC SCH40 PIPE & FITTINGS(ASTM D2846)



CPVC SCH40 PIPE & FITTINGS(ASTM D2846)

## CPVC PIPE

ITEM NO.:FGZ01



Size	Nom	e	D
1/2"		1.7	15.9
3/4"		2.0	22.2
1"		2.6	28.6
1-1/4"		3.2	34.9
1-1/2"		3.7	41.3
2"		4.9	54.0

## SOCKET

ITEM NO.:M01

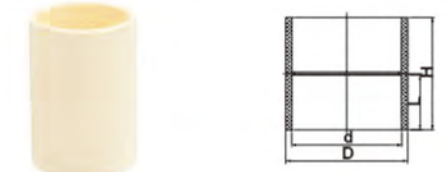

Size	Nom	d	D	L	H
1/2"		15.9	21.5	13.0	28.9
3/4"		22.2	26.8	18.0	39.5
1"		28.6	34.5	23.0	50.0
1-1/4"		34.9	41.8	28.1	60.0
1-1/2"		41.3	49.4	33.5	70.5
2"		54.0	64.4	43.5	90.5

## 90 DEG ELBOW

ITEM NO.:M02

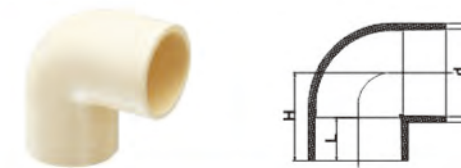

Size	Nom	d	D	L	H
1/2"		15.9	21.5	13.0	23.1
3/4"		22.2	26.8	18.0	31.4
1"		28.6	34.5	23.0	39.2
1-1/4"		34.9	41.8	28.1	47.4
1-1/2"		41.3	49.4	33.5	55.4
2"		54.0	64.4	43.5	72.5

## STRAIGHT TEE

ITEM NO.:M03



Size	Nom	d	D	I	H
1/2"		15.9	21.5	13.0	21.9
3/4"		22.2	26.8	18.0	31.0
1"		28.6	34.5	23.0	40.0
1-1/4"		34.9	41.8	28.1	47.8
1-1/2"		41.3	49.4	33.5	56.0
2"		54.0	64.4	43.5	72.5

## 45 DEG ELBOW

ITEM NO.:M04



Size	Nom	d	D	L	H
1/2"		15.9	20.0	13.0	18.8
3/4"		22.2	26.8	18.0	24.3
1"		28.6	34.5	23.0	30.9
1-1/4"		34.9	41.8	28.1	37.1
1-1/2"		41.3	49.5	33.5	44.0
2"		54.0	64.6	43.5	56.5

## MALE ADAPTER

ITEM NO.:M05

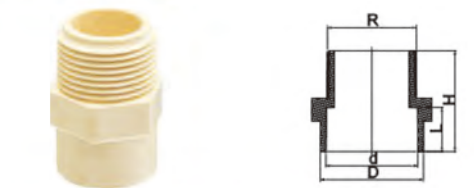

Size	Nom	d	D	R	L	H
1/2"		15.9	21.5	1/2"	13.0	41.4
3/4"		22.2	26.8	3/4"	18.0	42.0
1"		28.6	34.5	1"	23.0	47.0
1-1/4"		34.9	41.8	1-1/4"	28.1	55.0
1-1/2"		41.3	49.4	1-1/2"	33.5	62.0
2"		54.0	64.4	2"	43.5	75.0

## REDUCING BUSH

ITEM NO.:M06

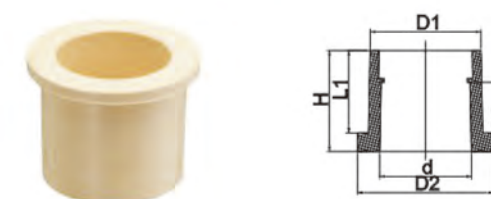

Size	Nom	d	D1	D2	L1	L2	H
3/4" x 1/2"		16.1	22.1	26.4	18.2	13.2	21.0
1" x 1/2"		16.1	28.6	34.6	20.4	16.3	25.0
1" x 3/4"		22.4	28.6	34.6	22.1	19.2	28.6

## REDUCING SOCKET

ITEM NO.:M07



Size	Nom	d1	d2	D1	D2	L1	L2	H
3/4" x 1/2"		15.9	22.2	20.0	26.8	18.0	13.0	33.7
1" x 1/2"		15.9	28.6	20.0	34.4	23.0	13.0	39.0
1" x 3/4"		22.2	28.6	26.8	34.4	23.0	18.0	44.0

**FEMALE ADAPTER**

ITEM NO.:M08

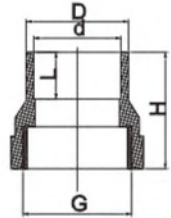

Size	Nom	d	D	G	L	H
1/2"	15.9	20.0	1/2"	13.0	35.0	
3/4"	22.2	26.8	3/4"	18.0	42.0	
1"	28.6	34.5	1"	19.3	50.0	
1-1/4"	34.9	41.8	1-1/4"	28.1	58.0	
1-1/2"	41.3	49.5	1-1/2"	33.5	68.0	
2"	54.0	64.6	2"	43.5	87.0	

**UNION**

ITEM NO.:M09

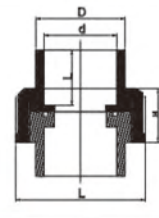

Size	Nom	d	D	L	H
1/2"	15.9	21.8	13.0	36.5	
3/4"	22.2	32.5	22.0	53.5	
1"	28.6	34.4	23.0	57.5	
1-1/4"	35.2	41.8	28.1	65.1	
1-1/2"	41.7	49.2	33.5	75.7	
2"	54.4	64.6	43.5	99.2	

**REDUCING TEE**

ITEM NO.:M10

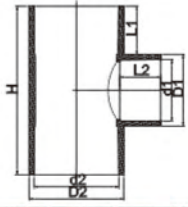

Size	Nom	d1	d2	D1	D2	L1	L2	H
3/4" x 1/2"	15.9	22.2	20.0	26.9	18.0	13.0	54.5	
1" x 1/2"	15.9	28.6	20.0	34.4	23.0	13.0	64.8	
1" x 3/4"	22.2	28.6	26.9	34.0	23.0	18.0	71.2	

**END CAP**

ITEM NO.:M11

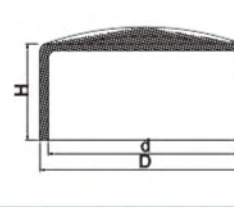

Size	Nom	d	D	H
1/2"	15.9	21.5	17.0	
3/4"	22.2	26.8	25.5	
1"	28.6	34.5	32.0	
1-1/4"	35.2	41.8	41.0	
1-1/2"	41.7	49.4	44.0	
2"	54.4	64.4	57.0	

**BRASS THREADED MALE ADAPTER**

ITEM NO.:M12

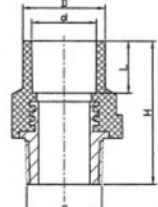

Size	Nom	d	D	d1	G	L	H
1/2"	15.9	20.1	1/2"	13	35		
3/4"	17.7	28.5	22.4	3/4"	18	49.6	
1"	23.5	35	28.8	1"	23	66.1	
1-1/4"	28.5	44	35.2	1-1/4"	28.1	73.6	
1-1/2"	33.5	51.5	41.7	1-1/2"	33.5	81	
2"	44	66	54.4	2"	43.5	97.1	

**BRASS THREADED FEMALE ELBOW**

ITEM NO.:M13

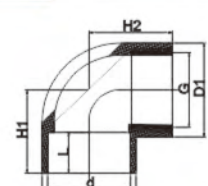

Size	Nom	d	D	D1	G	L	H1	H2
1/2"	15.9	20.0	32.1	1/2"	13.3	28.2	27.0	
3/4"	22.2	26.8	38.1	3/4"	18.7	33.6	33.7	
3/4" x 1/2"	28.7	34.2	32.1	1/2"	23.1	36.0	36.0	
1" x 1/2"	34.7	41.5	32.1	1/2"	28.3	40.5	39.4	

**BRASS THREADED FEMALE ADAPTER**

ITEM NO.:M14

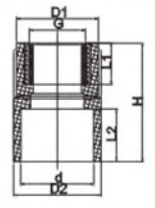

Size	Nom	d	D2	D1	G	L1	L2	H
1/2"	15.9	21.5	32.1	1/2"	18.0	15.0	33.7	
3/4"	22.2	26.8	38.1	3/4"	20.6	17.4	39.0	
1"	28.6	34.5	42.3	1"	23.0	18.0	44.0	
3/4" x 1/2"	22.2	26.8	32.1	1/2"	18.0	17.4	36.1	
1" x 1/2"	28.6	34.5	32.1	1/2"	18.0	18.0	38.4	

**BRASS THREADED FEMALE TEE**

ITEM NO.:M15

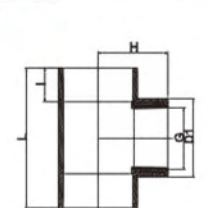

Size	Nom	d	D	D1	G	L	I	H
1/2"	15.9	20.0	33.2	1/2"	52.0	18.0	39.0	
3/4" x 1/2"	22.2	26.8	33.2	1/2"	68.5	18.0	31.5	
1" x 1/2"	28.6	34.5	34.9	1/2"	80.0	23.0	35.0	

**BRASS THREADED MALE TEE**

ITEM NO.:M16

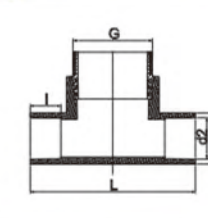

Size	Nom	G	d2	D2	I	L
1/2"	1/2"	15.9	21.5	13.0	21.9	
3/4" x 1/2"	1/2"	22.2	26.8	18.0	31.0	
1" x 1/2"	1/2"	28.6	34.5	23.0	40.0	

**CPVC CROSS**

ITEM NO.:M18

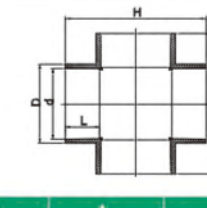

Size	Nom	d	D	L	H
1/2"	15.9	21.5	13.0	44.0	
3/4"	22.2	27.0	18.0	62.0	
1"	28.6	34.0	23.0	80.0	
1-1/4"	34.9	42.0	28.0	95.5	
1-1/2"	41.3	49.0	33.0	112.0	
2"	54.0	65.0	43.0	145.0	

**MALE COUPLING (COPPER THREAD)**

ITEM NO.:M20



Size	Nom	d	D	G	L	H
1/2"	15.9	21.7	1/2"	13	48	
3/4"	22.2	28.5	3/4"	18	53	
1"	28.6	35	1"	23	71	
1-1/4"	34.9	44	1-1/4"	28.1	80	
1-1/2"	41.3	51.5	1-1/2"	33.5	88	
2"	54	64.4	2"	38.5	94	

**STREET ELBOW**

ITEM NO.:M22

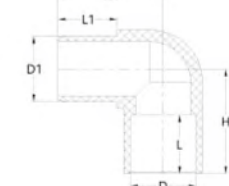

Size	Nom	H	H1	D1	D1	L	L1
1/2"	22.4	25.7	16	16	12.8	12.8	
3/4"	30.8	34.8	22.3	22.3	18.6	17.8	
1"	39	43	28.8	28.8	23.3	22.9	

**CPVC ELBOW WITH PLATE**

ITEM NO.:M17

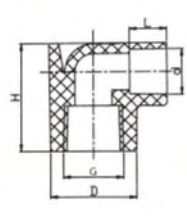

Size	Nom	d	D	G	H	L
1/2"	15.9	30	1/2"	38.2	13	

**FEMALE COUPLING (COPPER THREAD)**

ITEM NO.:M19

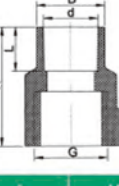

Size	Nom	d	D	G	L	H
1/2"	15.9	21.7	1/2"	13	42.5	
3/4"	22.2	28.5	3/4"	18	50	
1"	28.6	35	1"	23	65	
1-1/4"	34.9	44	1-1/4"	28.1	77	
1-1/2"	41.3	51.5	1-1/2"	33.5	84	
2"	54	64.4	2"	43.5	94	

**TANK COUPLING**

ITEM NO.:M21

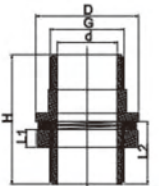

Size	Nom	d	D	G	L1	L2	H
1/2"	13.4	39.4	1/2"	8.0	30.0	66.0	
3/4"	19.0	45.4	3/4"	10.1	35.0	74.3	
1"	23.5	51.4	1"	12.0	40.0	82.0	
1-1/4"	31.0	61.0	1-1/4"	12.0	45.0	90.0	
1-1/2"	36.0	67.0	1-1/2"	14.0	50.0	98.0	
2"	45.0	79.0	2"	14.0	55.0	106.0	

**45 DEG STREET ELBOW**

ITEM NO.:M23

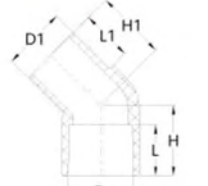

Size	Nom	H	H1	D1	D1	L	L1
1/2"	18.1	18.1	16.1	15.9	12.7	12.7	
3/4"	24.5	24.5	22.45	22.2	17.8	17.8	

CLAMP

ITEM NO.:M24

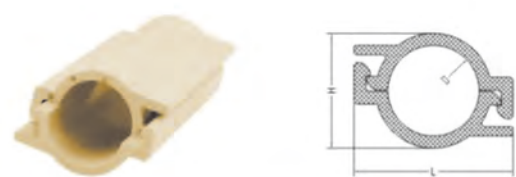

Size	Nom	D	L	H
1/2"		15.9	22.2	28.6
3/4"		29	39	46.5
1"		21.2	28	34.7

TEE MIXER

ITEM NO.:M26



Size	Nom	d	L	H	H1
1/2"		16.1	12.7	128	72

RUNNING TRAP

ITEM NO.:M33



Size	Nom	D	D1	L	L1
1/2"		16.0	105	210	29
3/4"		22.3	120	240	38.45

OVER BEND

ITEM NO.:M35

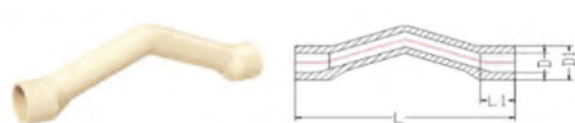

Size	Nom	D	D1	L	L1
1/2"		15.9	28.5	152	12.8
3/4"		22.2	32.5	193	17.9
1"		22.2	42.5	271	23.0
1-1/4"		28.6	42.6	260	28.2
1-1/2"		28.6	50.0	300	33.2
2"		28.6	64.6	320	43.5

EAR COUPLING ELBOW

ITEM NO.:M37



Size	Nom	D	H1	H	M
1/2"		34.57	29	37.3	1/2"
3/4"		28	21	31.3	3/4"

MALE PLUG

ITEM NO.:M25



Size	Nom	D	L	L1
1/2"		30	61.5	1/2"
3/4"		37.5	75.8	3/4"

45 DEG STREET ELBOW

ITEM NO.:M27



Size	Nom	H	H1	D1	D1	L	L1
1/2"		16.1	15.9	12.7	12.7	128	61.36

COMPRESSION COUPLING

ITEM NO.:M34



Size	Nom	D	L1	L
1/2"		16.5	36.5	95
3/4"		22.8	43.3	105
1"		29.0	52.0	115

CLIP

ITEM NO.:M36



Size	Nom	D	L	Z	H
1/2"		15.9	37.9	11.9	21.5
3/4"		22.2	45.7	11.9	28.5
1"		28.6	54.2	12.1	35.2
1-1/4"		34.9	70.2	14.3	42.2
1-1/2"		41.3	84.0	15.5	50.3
2"		54.0	94.0	15.7	64.7

COMPRESSION COUPLING

ITEM NO.:M38



Size	Nom	D	H1	H	M
1/2"		20.33	59.1	35.5	1/2"
3/4"		26.3	59.7	42.4	3/4"

TANK CONNECTOR

ITEM NO.:M39



Size	Nom	D	D1	L1	L	M
3/4"		28.5	22.2	50	74.8	1/2"
1"		34.5	28.6	50	78.0	3/4"

STOP VALVE

ITEM NO.:M41



Size	Nom	D	L	L1	Z	H	M
1/2"		15.9	54.6	47.5	88.5	54.0	1/2"

ANGLE VALVE

ITEM NO.:M43

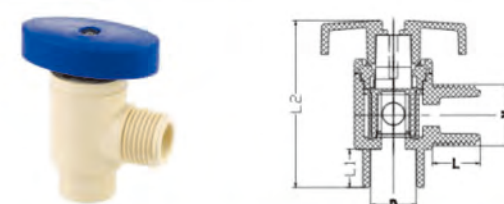

Size	Nom	M	L	L1	D	L2
1/2"		1/2"	16.5	13.3	15.72	57.9

CPVC SINGLE UNION VALVE

ITEM NO.:M45

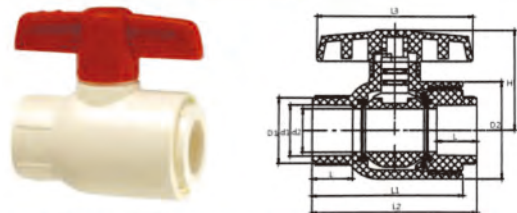

Size	Nom	d1	d2	D1	D2	L	L1	L2	L3	H
1/2"		16	12.4	22.7	35	13	56	59	52	34.4
3/4"		22.5	18	29.8	44	18	73	76.6	70	45
1"		28.8	24.5	36.8	55	23	86	94	89.4	56.8
1-1/4"		35.2	33	47.2	66.5	28.1	103	113	96.6	70
1-1/2"		41.7	35.5	54.8	73.3	33.5	115.8	131	108.2	79.1
2"		54.4	44	68.5	89	43.5	146.7	161.9	124.4	90.2

SHOWER KIT

ITEM NO.:M47



SIZE
1/2"

REDUCING TEE Y

ITEM NO.:M40



Size	Nom	D	D1	H	L1	L
3/4"X3/4"X1/2"		22.2	15.9	31.1	17.9	58.0
3/4"X1/2"X1/2"		22.2	15.9	26.0	17.9	38.9

ANGLE VALVE

ITEM NO.:M42



Size	Nom	D	L	L1	Z	H	M
1/2"		15.9	27.7	33.3	87.0	50.3	1/2"

CHECK VALVE

ITEM NO.:M44



Size	Nom	D	H	L	L1
1/2"		16.08	98.4	70.8	13

CPVC COMPACT BALL VALVE

ITEM NO.:M46

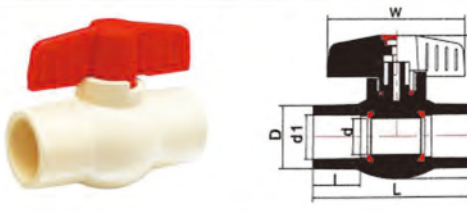

Size	Nom	d	d1	D	I	L	H1	H2	W
1/2"		12.4	15.9	24	19	68.5	58	40.7	60
3/4"		18.4	22.2	32	24	84	73	51.6	70.2
1"		20.5	28.6	38.4	25	91	77	52.3	79
1-1/4"		25	34.9	45.8	28.5	105.5	93.5	65.2	100
1-1/2"		30.6	41.3	53.5	33.5	121	104.8	72.3	108
2"		41	54	68.4	43.5	149	122	82	130

# CPVC SCH80 PIPE & FITTINGS(ASTM F439)



## CPVC SCH80 PIPE & FITTINGS(ASTM F439)

### CPVC ASTM SCH80 PIPES ITEM NO.:GGZ01



Size(mm)	1/2"	3/4"	1"	1-1/4"	1-1/2"	2"	2-1/2"	3"	4"
D(mm)	21.3	26.7	33.4	42.2	48.3	60.3	73	88.9	114.3
L(mm)	4m	4m	4m	4m	4m	4m	4m	4m	4m
Z(mm)	3.7	3.9	4.6	4.9	5.1	5.5	7.1	7.6	8.6

### 90 DEG ELBOW ITEM NO.:CS02



Size(mm)	1/2"	3/4"	1"	1-1/4"	1-1/2"	2"	2-1/2"	3"	4"
D(mm)	21.34	26.67	33.40	42.16	48.26	60.32	73.02	88.90	114.30
L(mm)	36.5	42.5	49.5	56.0	63.0	73.5	86.5	100.0	124.0
Z(mm)	24.0	27.0	30.0	33.0	36.0	39.0	46.0	49.0	59.0

### EQUAL TEE ITEM NO.:CS04



Size(mm)	1/2"	3/4"	1"	1-1/4"	1-1/2"	2"	2-1/2"	3"	4"
D(mm)	21.34	26.67	33.40	42.16	48.26	60.32	73.02	88.90	114.30
L(mm)	36.5	42.5	49.5	56.0	63.0	73.5	86.5	100.0	124.0
Z(mm)	24.0	27.0	30.0	33.0	36.0	39.0	46.0	49.0	59.0

### COUPLING ITEM NO.:CS01

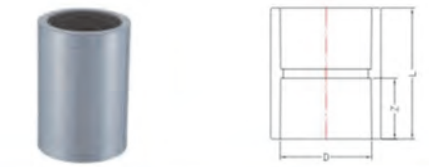

Size(mm)	1/2"	3/4"	1"	1-1/4"	1-1/2"	2"	2-1/2"	3"	4"
D(mm)	21.34	26.67	33.40	42.16	48.26	60.32	73.02	88.90	114.30
L(mm)	36.5	42.5	62.5	68.5	74.5	80.5	97.0	103.0	123.0
Z(mm)	24.0	27.0	30.0	33.0	36.0	39.0	46.0	49.0	59.0

### 45 DEG ELBOW ITEM NO.:CS03



Size(mm)	1/2"	3/4"	1"	1-1/4"	1-1/2"	2"	2-1/2"	3"	4"
D(mm)	21.34	26.67	33.40	42.16	48.26	60.32	73.02	88.90	114.30
L(mm)	30.5	34.5	39.5	45.0	49.0	54.5	66.0	72.0	88.0
Z(mm)	24.0	27.0	30.0	33.0	36.0	39.0	46.0	49.0	59.0

### REDUCING TEE ITEM NO.:CS05



Size(mm)	3/4"x1/2"	1"x1/2"	1"x3/4"	1-1/4"x3/4"	1-1/4"x1"	1-1/2"x1"	1-1/2"x1-1/4"	2"x1-1/4"
D(mm)	26.67	33.40	33.40	42.16	42.16	48.26	48.26	60.30
L(mm)	39.5	42.5	45.5	48.5	51.5	56.0	61.0	64.0
Z(mm)	27.0	30.0	30.0	33.0	33.0	36.0	36.0	39.0
D1(mm)	21.34	21.34	26.67	26.67	33.40	33.40	42.16	42.16
L1(mm)	39.0	42.0	45.5	50.0	53.0	57.5	61.0	67.0
Z1(mm)	24.0	24.0	27.0	27.0	30.0	30.0	33.0	33.0

Size(mm)	2"x1-1/2"	2-1/2"x1-1/2"	2-1/2"x2"	3"x2"	3"x2-1/2"	4"x2-1/2"	4"x3"
D(mm)	60.32	73.02	73.02	88.90	88.90	114.30	114.30
L(mm)	64.0	74.0	80.0	83.0	89.5	99.5	107.5
Z(mm)	39.0	46.0	46.0	49.0	49.0	59.0	59.0
D1(mm)	48.26	48.26	60.32	60.32	73.02	73.02	88.90
L1(mm)	70.0	76.5	79.5	87.5	107.0	107.0	110.0
Z1(mm)	36.0	36.0	39.0	39.0	46.0	46.0	49.0

REDUCING COUPLING

ITEM NO.:CS06



Size(mm)	3/8x1/2"	1/2x3/4"	1/2x3/4"	1-1/4x1"	1-1/2x1"	1-1/2x1-1/4"	2x1-1/2"
D(mm)	26.67	33.40	33.40	42.16	42.16	48.26	60.32
L(mm)	60.0	63.0	67.5	75.0	69.0	77.0	83.5
Z(mm)	27.0	30.0	30.0	33.0	33.0	36.0	39.0
D1(mm)	21.34	21.34	26.67	26.67	33.40	33.40	42.16
Z1(mm)	24.0	24.0	27.0	27.0	30.0	30.0	33.0

Size(mm)	2x1-1/2"	2-1/2x1-1/2"	2-1/2x2"	3"x2"	3"x2-1/2"	4"x2-1/2"	4"x3"
D(mm)	60.32	73.02	73.02	88.90	88.90	114.30	114.30
L(mm)	94.0	99.0	102.0	106.5	115.5	124.5	130.0
Z(mm)	39.0	46.0	46.0	49.0	49.0	59.0	59.0
D1(mm)	48.26	48.26	60.32	60.32	73.02	73.02	88.90
Z1(mm)	36.0	36.0	39.0	39.0	46.0	46.0	49.0

END CAP

ITEM NO.:CS08

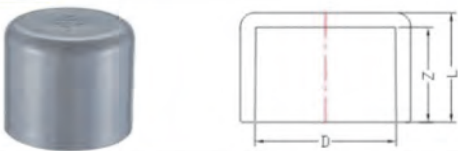

Size(mm)	1/2"	3/4"	1"	1-1/4"	1-1/2"	2"	2-1/2"	3"	4"
D(mm)	21.34	26.67	33.40	42.16	48.26	60.32	73.02	88.90	114.30
L(mm)	34.0	37.0	40.0	43.0	46.0	53.0	61.0	66.0	67.5
Z(mm)	24.0	27.0	30.0	33.0	36.0	39.0	46.0	49.0	59.0

FEMALE ELBOW 90°

ITEM NO.:CS10



Size(mm)	1/2"	3/4"	1"	1-1/4"	1-1/2"	2"
D(mm)	21.34	26.67	33.40	42.16	48.26	60.32
L(mm)	17.5	18.5	22.5	24.0	28.0	29.5
Z(mm)	31.2	33.5	42.5	48.5	54.2	63.5
Z1(mm)	32.6	40.0	48.0	61.0	61.0	63.2
M(mm)	1/2"	3/4"	1"	1-1/4"	1-1/2"	2"

FEMALE ADAPTER

ITEM NO.:CS12



Size(mm)	1/2"	3/4"	1"	1-1/4"	1-1/2"	2"	2-1/2"	3"	4"
D(mm)	21.34	26.67	33.40	42.16	48.26	60.32	73.02	88.90	114.30
L(mm)	50.5	56.5	62.5	68.5	74.5	80.5	97.0	103.0	123.0
Z(mm)	24.0	27.0	30.0	33.0	36.0	39.0	45.0	49.0	59.0
M(mm)	1/2"	3/4"	1"	1-1/4"	1-1/2"	2"	2-1/2"	3"	4"

REDUCING RING

ITEM NO.:CS07



Size(mm)	3/4x1/2"	1x3/4"	1-1/4x1"	1-1/4x1"	1-1/2x1-1/4"	2x1-1/2"	2-1/2x2"	4x3"
D(mm)	21.34	26.67	33.40	42.16	48.26	60.32	73.02	88.90
L(mm)	34.0	37.0	40.0	43.0	46.0	53.0	61.0	66.0
Z(mm)	24.0	27.0	30.0	33.0	36.0	39.0	46.0	49.0

UNION

ITEM NO.:CS09

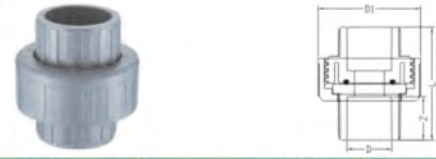

Size(mm)	1/2"	3/4"	1"	1-1/4"	1-1/2"	2"
D(mm)	21.34	26.67	33.40	42.16	48.26	60.32
L(mm)	54.0	60.0	68.0	76.0	84.0	93.0
Z(mm)	24.0	27.0	30.0	33.0	36.0	39.0
D1(mm)	48.5	56.2	64.0	75.7	83.4	98.3

REDUCING ELBOW (THREADED)

ITEM NO.:CS11

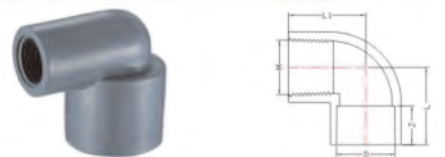

Size(mm)	3/4x1/2"	1x1/2"	1x3/4"
D(mm)	26.67	33.40	33.40
L(mm)	40.0	42.5	45.5
Z(mm)	27.0	30.0	30.0
D1(mm)	21.34	21.34	26.67
L1(mm)	40.0	42.0	45.5
Z1(mm)	24.0	24.0	27.0

MALE ADAPTER

ITEM NO.:CS13



Size(mm)	1/2"	3/4"	1"	1-1/4"	1-1/2"	2"	2-1/2"	3"	4"
D(mm)	21.34	26.67	33.40	42.16	48.26	60.32	73.02	88.90	114.30
L(mm)	50.5	56.5	62.5	64.0	69.0	75.5	93.5	99.5	113.5
Z(mm)	24.0	27.0	30.0	33.0	36.0	39.0	46.0	49.0	59.0
M(mm)	1/2"	3/4"	1"	1-1/4"	1-1/2"	2"	2-1/2"	3"	4"

FEMALE ELBOW

ITEM NO.:CS14



Size(mm)	1/2"	3/4"	1"
D(mm)	29.7	35.4	43.2
L(mm)	36.5	42.0	48.0
Z(mm)	24.0	27.0	30.0
L1(mm)	36.5	42.0	48.0
M(mm)	1/2"	1/2"	3/4"

MALE ELBOW

ITEM NO.:CS16



Size(mm)	1/2"	3/4"	1"
D(mm)	29.7	35.4	43.2
L(mm)	36.4	42.7	49.1
Z(mm)	24.0	27.0	30.0
L1(mm)	36.0	42.0	49.0
M(mm)	1/2"	3/4"	1"

FEMALE COUPLING (COPPER THREAD)

ITEM NO.:CS18



Size(mm)	1/2x1/2"	1/2x3/4"	3/4x3/4"	3/4x1/2"	1"x1"	1"x3/4"
D(mm)	21.34	21.34	26.67	26.67	33.40	33.40
L(mm)	19.0	19.0	21.0	21.0	26.0	26.0
Z(mm)	24.0	24.0	27.0	27.0	30.0	30.0
M(mm)	45.0	45.0	45.0	45.0	49.5	49.5

FEMALE TEE (COPPER THREAD)

ITEM NO.:M20



Size(mm)	1/2x1/2"	1/2x3/4"	3/4x3/4"	3/4x1/2"
D(mm)	21.34	21.34	26.67	26.67
L(mm)	34.0	34.0	37.0	37.0
Z(mm)	24.0	24.0	27.0	27.0
D1(mm)	42.5	42.5	42.5	42.5
L1(mm)	34.0	34.0	36.5	36.5

FEMALE CAP

ITEM NO.:CS15

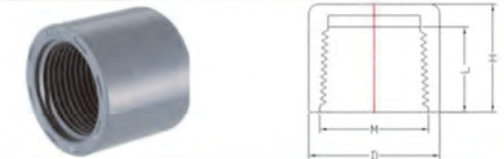

Size(mm)	1/2"	3/4"	1"
D(mm)	29.7	35.4	43.2
L(mm)	30.5	33.5	37.0
Z(mm)	24.0	27.0	30.0
M(mm)	1/2"	3/4"	1"

MALE COUPLING (COPPER THREAD)

ITEM NO.:CS17



Size(mm)	1/2"	3/4"	1"	1-1/4"	1-1/2"	2"
D(mm)	21.34	26.67	33.40	42.16	48.26	60.32
L(mm)	45.0	51.0	53.0	62.0	66.0	74.0
Z(mm)	24.0	27.0	30.0	33.0	36.0	39.0
M(mm)	1/2"	3/4"	1"	1-1/4"	1-1/2"	2"

90DEG FEMALE ELBOW (COPPER THREAD)

ITEM NO.:CS19

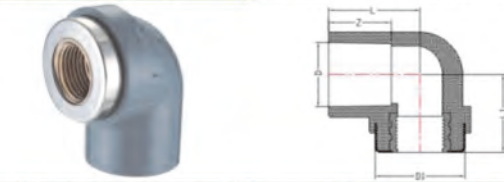

Size(mm)	1/2x1/2"	1/2x3/4"	3/4x3/4"	3/4x1/2"
D(mm)	21.34	21.34	26.67	26.67
L(mm)	29.0	29.0	31.0	31.0
Z(mm)	24.0	24.0	27.0	27.0
D1(mm)	42.5	42.5	42.5	42.5
L1(mm)	34.0	34.0	36.5	36.5

DOUBLE COPPER ELBOW

ITEM NO.:CS21

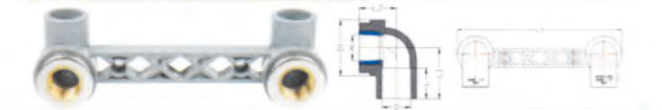

Size(mm)	D(mm)	D1(mm)	L(mm)	L1(mm)	L2(mm)	L3(mm)	M(mm)
1/2"	1.34	42.0	22.5	37.5	27.8	190.5	1/2"

CPVC VALVE

ITEM NO.:CS30



Size(mm)	1/2"	3/4"	1"	1-1/4"	1-1/2"	2"
D(mm)	21.4	26.7	33.4	42.2	48.3	60.3
L(mm)	19.5	22.5	26.5	28.6	32.0	35.5
Z(mm)	38.1	43.8	49.8	59.0	63.5	74.0
M(mm)	66.0	77.0	87.0	99.0	74.0	130.0

# PPR PIPE & FITTINGS



## PPR PIPE

ITEM NO.:B39



Size									
20	25	32	40	50	63	75	90	110	160

## COUPLING

ITEM NO.:B01

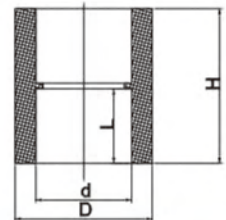

Size	Nom	D	d	L	H
20	27.4	19	15.7	34.3	
25	34.8	24	17.5	38	
32	42.4	30.9	19.2	41.8	
40	52.5	38.8	22.1	47.3	
50	66.3	48.9	25.1	53.8	
63	83.3	61.7	29.1	61.3	
75	99.2	73.4	32	68.4	
90	119.0	88.8	36	77	
110	147	108.3	42	89.8	
160	211	157	56.5	126	

## 90 DEG ELBOW

ITEM NO.:B02

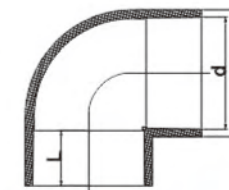

Size	Nom	D	d	L
20	19.0	27.4	16.1	
25	24.0	34.4	18.1	
32	31.0	42.1	20.1	
40	38.8	52.6	21.7	
50	48.9	66.1	25.1	
63	61.7	83.1	28.4	
75	73.4	99.2	32.0	
90	88.8	119.0	36.0	
110	108.3	146.7	42.0	
160	211	157	56.5	

## 45 DEG ELBOW

ITEM NO.:B03

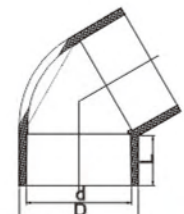

Size	Nom	d	D	L
20	19.0	27.4	15.8	
25	24.0	34.8	18.1	
32	31.0	42.4	20.1	
40	38.8	52.1	22.1	
50	48.9	65.7	25.1	
63	61.7	83.1	28.0	
75	73.4	99.0	30.4	
90	88.8	119.6	35.1	
110	108.3	146.7	42.0	
160	211	157	56.5	

## TEE

ITEM NO.:B04

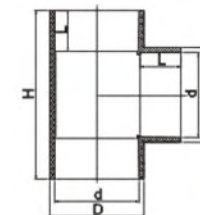

Size	Nom	d	D	L	H
20	19	27.3	14.6	50.4	
25	24	34.8	18.1	63	
32	30.9	42.4	20.1	74	
40	38.8	51.5	21.5	79.5	
50	48.9	64.8	23.8	97.2	
63	61.7	79.7	27.0	114.6	
75	73.4	99.2	32.0	141.7	
90	88.8	120.0	36.0	168.3	
110	108.3	146.0	42.0	197.4	
160	211	157	56.5	299	

## CAP

ITEM NO.:B06

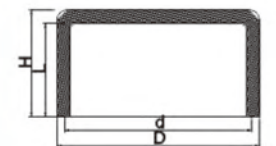

Size	Nom	d	D	L	H
20	19.0	27.4	16.1	23.3	
25	24.0	33.2	18.5	23.5	
32	30.9	42.6	20.1	30.2	
40	38.8	52.5	22.1	31.2	
50	48.9	66.1	25.1	35.3	
63	61.7	82.7	28.7	41.4	
75	73.4	99.2	34.2	53.2	
90	119.2	88.8	38	64.2	
110	145.8	108.3	46.7	69.8	
160	211	157	56.5	105.3	

**FEMALE COUPLING**

ITEM NO.:B07



Size	Nom	D	Z	L
20x1/2"	28	39.8	16.9	
25x1/2"	32.9	41.7	17.6	
25x3/4"	34.3	42.3	18.6	
32x1/2"	42.7	44.3	18.3	
32x3/4"	42.3	45.8	18	
32x1"	42.3	47	18	
40x1-1/4"	52.6	48.6	20.2	
50x1-1/2"	64.7	49.8	22.4	
63x2"	83.3	51.4	25.1	

**FEMALE ELBOW**

ITEM NO.:B09

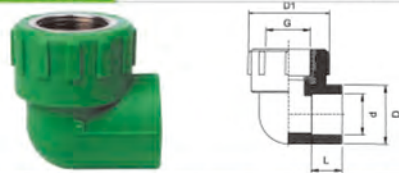

Size	Nom	d	D	G	D1	L
20x1/2"	19	27.4	1/2"	38	17.8	
20x3/4"	19	27.4	3/4"	44	18.8	
25x1/2"	24	34.8	1/2"	39	17.8	
25x3/4"	24	34.8	3/4"	44	18.8	
32x1/2"	30.6	42.6	1/2"	38.7	18.1	
32x3/4"	30.6	42.6	3/4"	44.8	18.8	
32x1"	30.6	42.6	1-1/4"	53.3	18	
40x1-1/4"	38.8	52.5	1-1/4"	62.4	20.1	
50x1-1/2"	48.9	66.3	1-1/2"	69.8	21.7	
63x2"	61.7	83.3	2"	79.2	25.1	

**REDUCING TEE**

ITEM NO.:B11

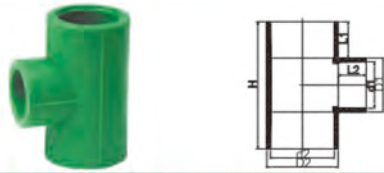

Size	Nom	d1	d2	D1	D2	L1	L2	H
25x20x25	19.0	23.0	27.2	34.3	16.4	15.5	52.3	
32x20x32	19.0	30.9	27.4	42.4	17.8	16.1	55.7	
32x25x32	24.0	30.9	34.8	42.4	20.1	17.5	64.2	
40x20x40	19.0	38.8	28	52.6	22.1	16.1	65.8	
40x25x40	24.0	38.8	35.3	52.6	22.1	18.1	70.8	
40x32x40	30.9	38.8	42.4	52.6	22.1	21.2	81.0	
50x20x50	19.0	48.9	28.2	66.1	25.1	16.0	75.2	
50x25x50	24.0	48.9	35.4	66.1	25.1	18.1	77.0	
50x32x50	30.9	48.9	42.8	66.1	25.1	20.1	83.4	
50x40x50	38.8	48.9	53.0	66.1	25.1	22.1	94.7	
63x20x63	19.0	61.7	28.0	83.1	29.1	18.1	83.4	
63x25x63	24.0	61.7	35.4	83.1	29.1	18.1	84.4	
63x32x63	30.9	61.7	42.4	83.1	29.1	20.1	91.2	
63x40x63	38.8	61.7	52.6	83.1	29.1	22.1	103.0	
63x50x63	52.6	61.7	66.1	83.1	29.1	25.1	112.6	
75x20x75	19.0	73.4	28.3	99.2	32.0	16.3	89.2	
75x25x75	24.0	73.4	35.4	99.2	32.0	18.1	92.5	
75x32x75	30.9	73.4	42.4	99.2	32.0	20.9	97.8	
75x40x75	38.8	73.4	53.2	100.3	32.0	22.1	106.7	
75x50x75	52.6	73.4	66.1	99.2	32.0	25.1	119.9	
75x63x75	61.7	73.4	83.1	99.2	32.0	29.1	130.0	
90x40x90	119.6	53.4	88.8	38.8	36	22.1	114.2	
90x50x90	120.6	66.6	88.8	52.6	36	25.1	126.5	
90x63x90	120.6	84.2	88.8	61.7	36	29.1	124.2	
90x75x90	120.6	99.2	88.8	73.4	36	32	15.9	
110x50x110	147.5	67.6	107.5	52.6	42	26.1	138.2	
110x63x110	147.5	84.1	107.5	61.7	42	30.0	151.0	
110x75x110	147.8	99.9	107.5	73.4	42	32	162.4	
110x90x110	146.2	119.6	107.5	88.8	42	36	178	

**MALE COUPLING**

ITEM NO.:B08

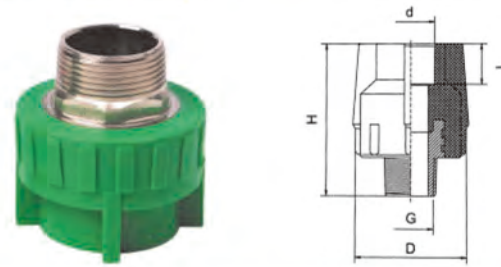

Size	Nom	d	D	G	H	L
20x1/2"	19	44	1/2"	61.7	16.1	
25x1/2"	24	44	1/2"	62	18.1	
25x3/4"	24	43.4	3/4"	61.5	18.1	
32x1/2"	30.5	46.4	1/2"	64	20.1	
32x3/4"	30.5	49.1	3/4"	62	20.1	
32x1"	30.9	64.4	1"	78.3	20.1	
40x1-1/4"	38.8	76.8	1-1/4"	93.5	22.1	
50x1-1/2"	48.9	86	1-1/2"	94.4	25.1	
63x2"	61.7	95	2"	112	29.1	

**MALE ELBOW**

ITEM NO.:B10

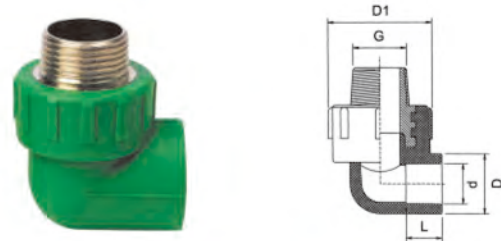

Size	Nom	d	D	G	D1	L
20x1/2"	19	27.4	1/2"	38	17.8	
20x3/4"	19	27.4	3/4"	44	18.8	
25x1/2"	24	34.8	1/2"	39	17.8	
25x3/4"	24	34.8	3/4"	44	18.8	
32x1/2"	30.6	42.6	1/2"	38.7	18.1	
32x3/4"	30.6	42.6	3/4"	44.8	18.8	
32x1"	30.6	42.6	1-1/4"	53.3	18	
40x1-1/4"	38.8	52.5	1-1/4"	62.4	20.1	
50x1-1/2"	48.9	66.3	1-1/2"	69.8	21.7	
63x2"	61.7	83.3	2"	79.2	25.1	

**UNION**

ITEM NO.:B12



Size	Nom	d	D	I	L	H
20	19.0	27.4	16.1	52.3	48.6	
25	24.0	34.8	18.4	57.3	51.9	
32	30.3	41.0	27.4	62.8	64.2	
40	38.8	52.0	31.0	82.2	86.4	
50	46.9	61.5	34.0	98.3	90.5	
63	58.5	75.8	38.6	120.0	107.0	

**FEMALE TEE**

ITEM NO.:B13



Size	Nom	d	D	G	D1	L	H
20x1/2"	19	27.4	1/2"	38.3	15.8	55	
20x3/4"	19	27.4	3/4"	44.8	18.5	57.5	
25x1/2"	24	34.8	1/2"	38.3	18.4	59	
25x3/4"	24	34.8	3/4"	44.8	18.5	62.6	
32x1/2"	30.6	42.6	1/2"	38.3	19.5	66.5	
32x3/4"	30.6	42.6	3/4"	44.8	18.5	70.7	
32x1"	30.6	42.6	1-1/4"	52.2	19.2	76.1	
40x1-1/4"	38.8	52.5	1-1/4"	62.4	20.1	79.5	
50x1-1/2"	48.9	66.3	1-1/2"	69.8	21.7	97.2	
63x2"	61.7	83.3	2"	79.2	25.1	114.6	

**MALE UNION**

ITEM NO.:B15



Size	Nom	d	D	A	I	L	G
20x1/2" M	19	26.4	39.3	16	53.6	1/2"	
25x3/4" M	24	34.5	50.2	17.7	59.7	3/4"	
32x1" M	30.9	42.5	59.9	19.3	67	1"	
40x1-1/4" M	38.8	52.1	74.2	21	73	1-1/4"	
50x1-1/2" M	48.9	65.4	91.2	24	80.5	1-1/2"	
63x2" M	61.7	79	104	27	89.2	2"	

**REDUCING SOCKET**

ITEM NO.:B17



Size	Nom	d1	d2	D1	D2	L1	L2	H
S25x20	19.0	24.0	27.4	34.8	16.1	18.1	34.4	
S32x20	19.0	30.9	27.4	42.4	16.1	20.1	38.0	
S32x25	24.0	30.9	34.8	42.4	17.4	20.1	39.6	
S40x20	19.0	38.8	27.4	52.6	16.1	22.1	50.0	
S40x25	24.0	38.8	34.8	52.6	18.1	22.1	49.6	
S40x32	30.9	38.8	42.4	52.6	20.1	22.1	44.3	
S50x25	24.0	48.9	34.8	66.0	18.1	25.1	57.0	
S50x32	30.9	48.9	42.4	66.0	20.1	25.1	56.0	
S50x40	38.8	48.9	52.6	66.1	22.1	25.1	50.2	
S63x20	19.0	61.7	27.4	82.7	16.1	29.1	62.5	
S63x25	24.0	61.7	34.8	82.7	18.1	29.1	62.7	
S63x32	30.9	61.7	42.4	82.7	20.1	29.1	63.4	
S63x40	38.8	61.7	53.0	83.1	22.1	29.1	63.3	
S63x50	48.9	61.7	66.7	83.1	25.1	29.1	56.7	
S75x40	99.2	73.4	32	53.2	38.8	22.1	69.0	
S75x50	99.2	73.4	32	66.6	48.9	25.1	69	
S75x63	99.2	73.4	32	83.1	61.7	29.1	66.5	
S90x50	119.0	88.8	36	66.8	48.9	25.1	78.5	
S90x63	119.6	88.8	39	83.1	61.7	29.1	82.7	
S90x75	119.6	88.8	39	99.2	73.4	32	74.8	
S110x63	145.5	108.3	42	84.4	61.7	30	91	
S110x75	145.5	108.3	42	100.0	73.4	32	91.4	
S110x90	146.0	108.3	42	121.0	88.8	37	82.0	
S160x110	211	157	56.5	145.5	108.5	42	125	

**MALE TEE**

ITEM NO.:B14

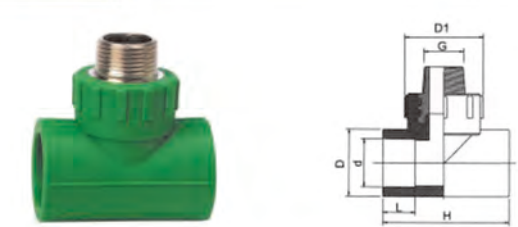

Size	Nom	d	D	G	D1	L	H
20x1/2"	19	27.4	1/2"	38.3	15.8	55	
20x3/4"	19	27.4	3/4"	44.8	18.5	57.5	
25x1/2"	24	34.8	1/2"	38.3	18.4	59	
25x3/4"	24	34.8	3/4"	44.8	18.5	62.6	
32x1/2"	30.6	42.6	1/2"	38.3	19.5	66.5	
32x3/4"	30.6	42.6	3/4"	44.8	18.5	70.7	
32x1"	30.6	42.6	1-1/4"	52.2	19.2	76.1	
40x1-1/4"	38.8	52.5	1-1/4"	62.4	20.1	79.5	
50x1-1/2"	48.9	66.3	1-1/2"	69.8	21.7	97.2	
63x2"	61.7	83.3	2"	79.2	25.1	114.6	

**FEMALE UNION**

ITEM NO.:B16



Size	Nom	d	D	A	I	L	G
20x1/2" F	19	27.8	43.7	16	42.6	1/2"	
25x3/4" F	24	34.5	50.2	17.7	46	3/4"	
32x1" F	30.9	42.5	59.9	19.3	49	1"	
40x1-1/4" F	38.8	52.1	74.2	21	53.5	1-1/4"	
50x1-1/2" F	48.9	65.4	91.2	24	57	1-1/2"	
63x2" F	61.7	79	104	27	63	2"	

**BALL VALVE**

ITEM NO.:B18

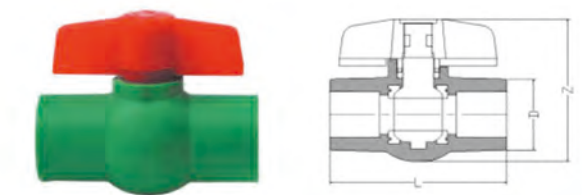

Size	Nom	D	L	Z
20		27.3	80.5	72

**STOP VALVE** ITEM NO.:B20

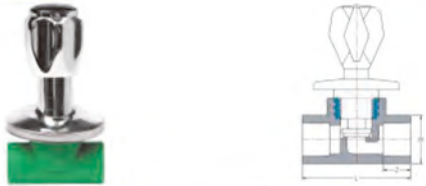

Size	Nom	D	L	Z
20	28	73.6	16	
25	33.2	80.5	16.5	
32	43.2	87.5	17.3	

**CONCEALED VALVE** ITEM NO.:B22

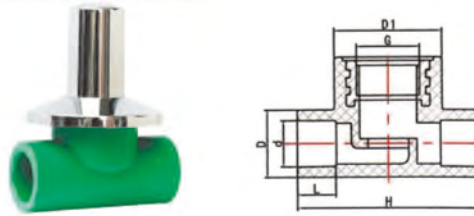

Size	Nom	d	D	D1	L	H
20	19	28	44.8	16	73.6	
25	24	33.2	56	16.5	80.5	
32	30.9	43.2	53.5	17.3	80.5	

**TRUE UNION BALL COCK** ITEM NO.:B24



Size	Nom	d1	d2	D1	I	L	H	A
20	19	15	27.4	19	92.8	37.5	40.5	
25	24	20	34.8	19	101.2	45.2	48.4	
32	30.9	26.9	42.4	21	114.5	51.7	57.3	
40	38.8	32	52.6	22.7	144.1	62	75.1	
50	48.9	42	66.1	25.7	175.8	69.8	92.7	
63	61.7	51	83	29.7	202.8	86.25	108	

**REDUCING ELBOW** ITEM NO.:B27



Size	Nom	d	d1	D	D1	L	L1
L25x20	19.0	24.0	27.4	34.8	16.1	18.1	
L32x20	19.0	30.9	27.4	42.4	16.1	20.1	
L32x25	24.0	30.9	34.8	42.4	18.1	20.1	
L40x20	19.0	38.8	27.4	52.6	16.1	22.1	
L40x25	24.0	38.8	34.8	52.6	18.1	22.1	
L40x32	30.9	38.8	42.4	52.6	20.1	22.1	
L50x20	19.0	48.9	27.4	66.0	16.1	25.1	
L50x25	24.0	48.9	34.8	66.0	18.1	25.1	
L50x32	30.9	48.9	42.4	66.0	20.1	25.1	
L50x40	38.8	48.9	52.6	66.1	22.1	25.1	
L63x20	19.0	61.7	27.4	82.7	16.1	29.1	
L63x25	24.0	61.7	34.8	82.7	18.1	29.1	
L63x32	30.9	61.7	42.4	82.7	20.1	29.1	
L63x40	38.8	61.7	53.0	83.1	22.1	29.1	
L63x50	48.9	61.7	66.7	83.1	25.1	29.1	

**SHORT BYPASS BEND** ITEM NO.:B21



Size	Nom	d	D	D1	I	L1	L
20	19.0	28.0	32.3	15.3	27.4	77.4	
25	24.0	33.0	38.1	17.9	32.0	97.3	
32	30.9	37.5	42.4	17.0	33.1	100.9	

**HEAVY STOP VALVE** ITEM NO.:B23

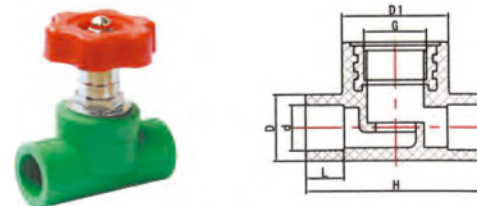

Size	Nom	d	D	G	D1	L	H
20	19	28.6	1/2"	34.8	16.1	70.7	
25	24	36.4	3/4"	44.7	18.1	83	
32	31	43	3/4"	45.2	20.1	86.5	
40	38.6	55.6	1"	55.5	22.5	97.4	
50	48.9	70.1	1-1/4"	66.3	25.5	121.6	
63	61.7	87.1	1-1/2"	74.8	28.7	133.1	

**MALE BRASS BALL COCK** ITEM NO.:B25



Size	Nom	d1	d2	D	G	A	H1	H2	L
20x1/2" M	18.6	20.0	25.2	1/2"	28.6	16.8	9.2	59.4	
25x3/4" M	23.7	25.5	31.2	3/4"	38.9	18.0	10.6	65.2	
32x1" M	30.9	31.9	39.5	1"	48.1	19.9	11.0	73.6	

**LOW FOOTED PIPE CLAMP** ITEM NO.:B28

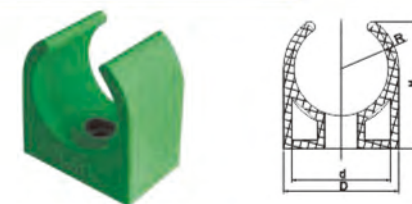

Size	Nom	d	D	R	H
16	16	20.2	15	11.5	
20	20.5	24	19.5	26	
25	25	29.4	24.3	31.4	
32	32.2	36.3	30.8	37.8	
40	40	44.1	38.6	46.3	

**WELDING MACHINE** ITEM NO.:B30



Size	20-32	20-63
------	-------	-------

**LUXURY BALL VALVE** ITEM NO.:B32

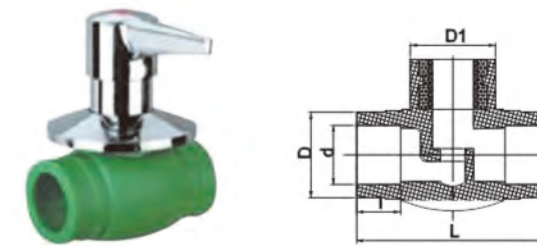

Size	Nom	d	D	I	L	D1
20	19	28	16.1	76.2	45	
25	24	35.5	18.1	81	46	
32	31	43.2	20.4	88.3	47	

**DOUBLE ELBOW** ITEM NO.:B40

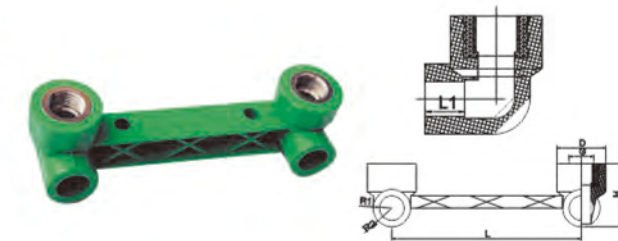

Size	Nom	G	D	R1	R2	L1	L	H
20x1/2" M	1/2"	39	19	29.8	16.4	147	48.9	
25x3/4" M	1/2"	39	24	36	18.7	152	56.6	

**NEW LUXURIOUS STOP VALVE** ITEM NO.:B31

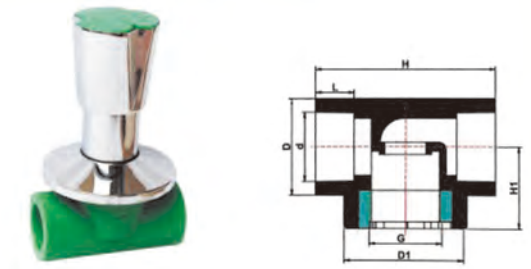

Size	Nom	d	D	D1	L	H	H1
20	19	28	44.8	16	73.6	29.4	
25	24	33.2	56	16.5	80.5	35.9	
32	30.9	43.2	53.5	17.3	80.5	36.4	

**PLUG** ITEM NO.:B37

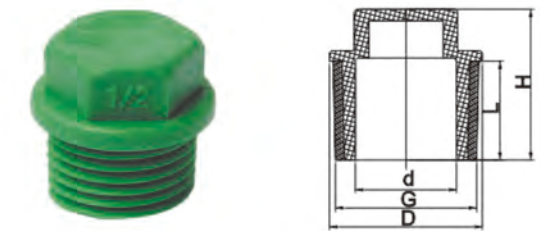

Size	Nom	d	D	G	L	H
20x1/2" M	14.8	22.2	1/2"	13.4	21.4	
25x3/4" M	16.5	32.6	3/4"	12.8	22.9	
32x1" M	25.4	35	1"	14.6	24.6	

**PPR DOUBLE FEMALE TEE** ITEM NO.:B41



Size	Nom	G	D	R1	R2	L1	L	H
20x1/2" M	1/2"	39	19	29.8	16.4	147	48.9	
25x3/4" M	1/2"	39	24	36	18.7	152	56.6	

NEW LUXURIOUS STOP VALVE(I)

ITEM NO.:B42

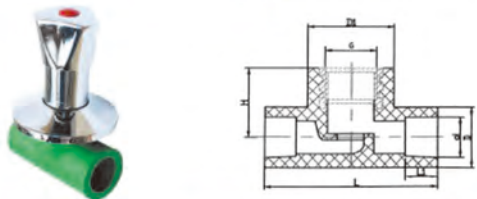

Size	Nom	d	D	D1	L	L1	H1
20	19	28.6	34.8	70.7	16.1	29.4	
25	24	36.4	44.7	83	18.1	35.9	
32	31	43	45.2	86.51	20.1	36.4	

BALL VALVE(PLASTIC,BRASS,STEEL)

ITEM NO.:B53

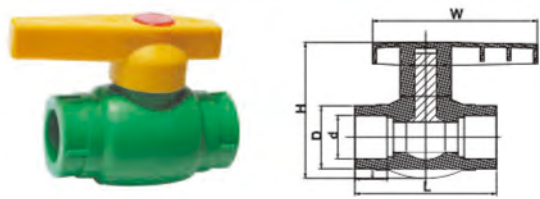

Size	Nom	d	D	I	L	H	W
20	19	27.3	14.6	73.4	68.1	86.3	
25	24	34.8	17.7	77.3	72.5	90.0	
32	30.9	42.4	20.1	79.5	74.4	93.4	
40	38.8	51.5	21.5	83.1	78.2	95.3	
50	48.9	64.8	23.8	88.6	83.0	98.0	
63	61.7	79.7	27.0	94.3	90.2	101.5	

UNION COUPLER

ITEM NO.:B56

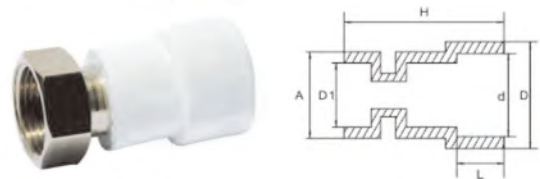

Size	Nom	A	D	d	L	D1	H
20x1/2"	43	27	19	16	1/2"	52	
25x3/4"	50	34	24	17.7	3/4"	58	
32x1"	58	42	30	19.3	1"	64	

UNION TEE

ITEM NO.:B58

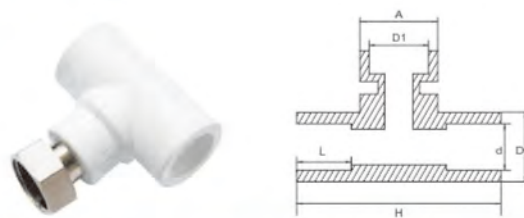

Size	Nom	D	d	L	D1	H	A
20x1/2"	27	19	16	1/2"	56	43	

STRAIGHT CROSS

ITEM NO.:B52

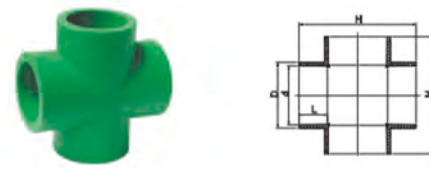

Size	Nom	d	D	L	H
20	19.0	27.4	16.0	53.0	
25	24.0	34.8	18.0	63.0	
32	31.0	42.4	20.0	74.0	
40	38.8	51.5	21.5	79.5	
50	48.9	64.8	23.8	97.2	
63	61.7	79.7	27.0	114.6	

NEW LUXURIOUS STOP VALVE(II)

ITEM NO.:B55

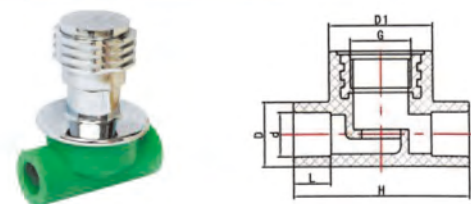

Size	Nom	d	D	D1	L	H
20	19	28	45	16.1	76.2	
25	24	35.5	46	18.1	81	
32	31	43.2	47	20.4	88.3	

UNION ELBOW

ITEM NO.:B57



Size	Nom	D	d	L	D1	H	A
20x1/2"	27	19	16	1/2"	52	43	
25x1/2"	34	24	18	1/2"	58	43	
25x3/4"	34	24	18	3/4"	60	50	
32x1"	58	42	20	1"	65	64	

FILTER

ITEM NO.:B62

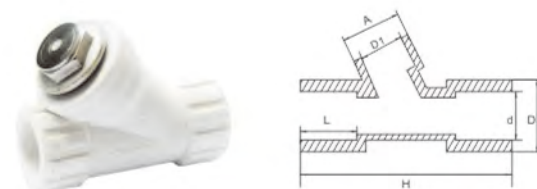

Size	Nom	D	d	L	D1	H	A
20x1/2"	27	19	16	1/2"	56	43	
20x3/4"	27	19	16	3/4"	62	47	
25x1/2"	34	24	18	1/2"	64	43	
25x3/4"	34	24	18	3/4"	64	48	
32x1"	42.5	30	20	1"	80	63	

PPR DOUBLE FEMALE ELBOW

ITEM NO.:B63



Size
20*1/2
25*1/2

PLUS TEE

ITEM NO.:B65



Size
20
25
32

S-TYPE ELBOW

ITEM NO.:B67



Size
20
25
32

CORNER TEE

ITEM NO.:B69



Size
20
25
32

REDUCING FEMALE ELBOW

ITEM NO.:B64



Size
20*1/2
25*1/2

PLUS ELBOW

ITEM NO.:B66



Size
20
25
32

CROSS

ITEM NO.:B68



Size
20
25
32

CROSS

ITEM NO.:B70



Size
------

PRESSURE FOR HOT & COLD

PRESSURE FOR HOT & COLD

**EQUAL SOCKET**

ITEM NO.:B100



Size	Reduce socket
S20	S25x20
S25	S32x20
S32	S32x25

**EQUAL TEE**

ITEM NO.:B102



Size
S20
S25
S32

**DOUBLE ELBOW WITH SEAT**

ITEM NO.:B104



Size
ZL20x1/2
FZL25x1/2
FZL32x1/2F

**MALE SOCKET**

ITEM NO.:B106



Size	Size
S20x1/2M	S32x1/2M
S25x1/2M	S32x3/4M
S25x3/4M	S32x1"M

**90°ELBOW**

ITEM NO.:B101



Size
L20
L25
L32

**REDUCE TEE**

ITEM NO.:B103



Size
T25x20x25
T32x20x32
T32x25x32

**FEMALE SOCKET**

ITEM NO.:B105



Size	Size
S20x1/2F	S32x1/2F
S25x1/2F	S32x3/4F
S25x3/4F	S32x1"F

**FEMALE ELBOW**

ITEM NO.:B107



Size	Size
L20x1/2F	L32x1/2F
L25x1/2F	L32x3/4F
L25x3/4F	L32 x1"F

**MALE ELBOW**

ITEM NO.:B108



Size	Size
L20x1/2M	L32x1/2M
L25x1/2M	L32x3/4M
L25x3/4M	L32 x1"M

**MALE TEE**

ITEM NO.:B110



Size	Size
T20x1/2M	T32x1/2M
T25x1/2M	T32x3/4M
T25x3/4M	T32x1"M

**THERMOSTATIC SOCKET**

ITEM NO.:B112



Size
20x1/2
25x3/4

**THERMOSTATIC ELBOW**

ITEM NO.:B114



Size
20x1/2
25x3/4

**FEMALE TEE**

ITEM NO.:B109



Size	Size
T20x1/2F	T32x1/2F
T25x1/2F	T32x3/4F
T25x3/4F	T32 x1"F

**PPR STOP BALL VALVE(NEW DESIGN)**

ITEM NO.:B111



Size
D20
D25
D32

**THERMOSTATIC SOCKET(WITH RING)**

ITEM NO.:B113



Size
20x1/2
25x3/4

**THERMOSTATIC ELBOW(WITH RING)**

ITEM NO.:B115



Size
20
25
32

PRESSURE FOR HOT & COLD

PRESSURE FOR HOT & COLD

**THERMOSTATIC SOCKET(WITH RING)** ITEM NO.:B116



Size

- 20
- 25

**THERMOSTATIC ELBOW(WITH RING)** ITEM NO.:B117



Size

- 20
- 25

**UNION TEE** ITEM NO.:B122



Size

- 20
- 25
- 32

**UNION ELBOW** ITEM NO.:B123



Size

- 20
- 25
- 32

**Y TYPE FILTER** ITEM NO.:B118



Size

- 20
- 25
- 32

**Y TYPE TEE** ITEM NO.:B119



Size

- 20
- 25
- 32

**UNION SOCKET** ITEM NO.:B124



Size

- 20
- 25
- 32

**UNION TEE** ITEM NO.:B125



Size

- 20
- 25
- 32

**Y TYPE TEE** ITEM NO.:B120



Size

- 20
- 25
- 32

**UNION SOCKET** ITEM NO.:B121



Size

- 20
- 25
- 32

**UNION ELBOW** ITEM NO.:B126



Size

- 20
- 25
- 32

**SHOWER KIT** ITEM NO.:B127



Size

- 20

# PP COMPRESSION FITTINGS SERIES



## PP ADDING EXIT

ITEM NO.:F01

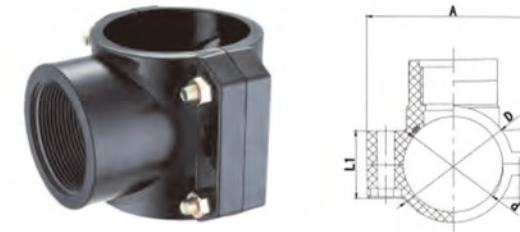

Size	Nom	d	D	A	L1
25	25	34	76	26	
32	32	41	78	27	
40	40	50	85	32	
50	50	60	85.5	34	
63	63	74.2	100	36	
75	75	89	117.6	45	
90	90	105	138	46	
110	110	126.4	158	47.2	
125	125	150.3	180	49	
160	160	181	211	51	
200	200	222.6	265	57.6	
250	250	271.6	323.4	63.2	

## PP 90DEG ELBOW

ITEM NO.:F03

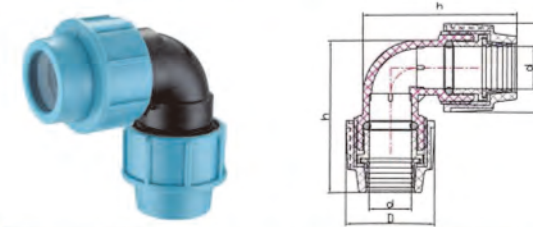

Size	Nom	d	D	H
20	21	44	76	
25	26	56	96	
32	33	65	116	
40	41	80	145	
50	51	92	163	
63	64	114	195	
75	76	128	227	
90	91	152	264	
110	111	182	307	

## PP END CAP

ITEM NO.:F05

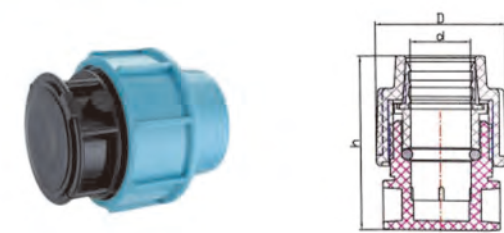

Size	Nom	d	D	h
20	21	44	59	
25	26	56	76	
32	33	65	88	
40	41	80	113	
50	51	92	127	
63	64	114	137	
75	76	128	160	
90	91	152	179	
110	111	182	200	

## PP COUPLING

ITEM NO.:F02



Size	Nom	d	D	L
20	21	44	100	
25	26	56	130	
32	33	65	149	
40	41	80	193	
50	51	92	216	
63	64	114	233	
75	76	128	276	
90	91	152	311	
110	111	182	350	

## PP ELBOW WALL PLATED

ITEM NO.:F04

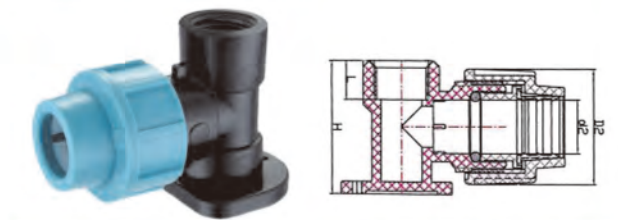

Size	Nom	d2	D2	L	H
20	21	44	16	62	
25	26	56	19	65	
32	33	65	22	69	
40	41	80	24	83	
50	51	92	26	97	
63	64	114	28	118	
75	76	128	33	131	
90	91	152	35	158	
110	111	182	40	190	

## PP FEMALE ADAPTER

ITEM NO.:F06



Size	Nom	d	D	D1	G	L	h
20x1/2"	21	44	31.6	1/2"	16	75	
20x3/4"	21	44	38.6	3/4"	19	78	
25x1/2"	26	56	31.6	1/2"	16	92	
25x3/4"	26	56	38.6	3/4"	19	95	
25x1"	26	56	47.4	1"	22	98	
32x1"	33	65	47.4	1"	22	110	
40x1-1/4"	41	80	62	1-1/4"	24	137	
50x1-1/2"	51	92	67	1-1/2"	24	151	
63x2"	64	114	81.2	2"	28	165	
75x2-1/2"	76	128	105	2-1/2"	33	193	
90x3"	91	152	126	3"	35	214	
110x4"	111	182	157	4"	40	240	

PP FEMALE ELBOW

ITEM NO.:F07

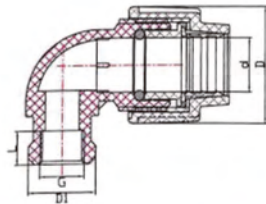

Size	Nom	d	D	D1	G	L
20x1/2"	21	44	31.6	1/2"	16	
25x3/4"	26	56	38.6	3/4"	19	
32x1"	33	65	47.4	1"	22	
40x1-1/4"	41	80	62	1-1/4"	24	
50x1-1/2"	51	92	67	1-1/2"	24	
63x1-1/2"	64	114	67	2"	24	
63x2"	64	114	81.2	2"	28	
75x2"	76	128	81.2	2"	28	
75x2-1/2"	76	128	105	2-1/2"	33	
90x3"	91	152	126	3"	35	
110x4"	111	182	157	4"	40	

PP FEMALE TEE

ITEM NO.:F08

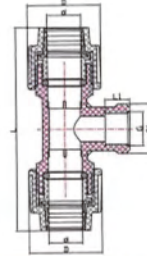

Size	Nom	d	D	D1	G	L	L1
20x1/2"	21	44	31.6	1/2"	125	16	
20x3/4"	21	44	38.6	3/4"	125	19	
25x1/2"	26	56	31.6	1/2"	158	16	
25x3/4"	26	56	38.6	3/4"	158	19	
25x1"	26	56	47.4	1"	158	22	
32x3/4"	33	65	38.6	3/4"	189	19	
32x1"	33	65	47.4	1"	189	22	
40x1"	41	80	47.4	1"	239	22	
40x1-1/4"	41	80	62	1-1/4"	239	24	
50x1-1/2"	51	92	67	1-1/2"	262	24	
63x1-1/2"	64	114	67	1-1/2"	303	24	
63x2"	64	114	81.2	2"	303	28	
75x2-1/2"	76	128	105	2-1/2"	365	33	
90x3"	91	152	126	3"	420	35	
110x4"	111	182	157	4"	482	40	

PP MALE TEE

ITEM NO.:F09

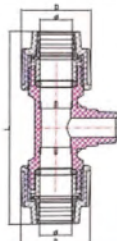

Size	Nom	d	D	L
20	21	44	125	
25	26	56	158	
32	33	65	189	
40	41	80	239	
50	51	92	262	
63	64	114	303	
75	76	128	365	
90	91	152	420	
110	111	182	482	

FLANGE

ITEM NO.:F10

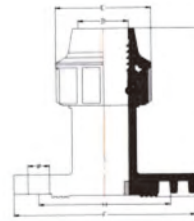

Size	Nom	E	L	F	H
40x1-1/2"	80	140	152	110	
50x1-1/2"	96	165	152	110	
50x2"	96	165	164	125	
63x2"	115	194	164	125	
63x2-1/2"	115	194	184	145	
75x2-1/2"	129	209	184	145	
75x3"	129	209	200	160	
90x3"	155	229	200	160	
90x4"	155	229	220	180	
110x4"	184	256	220	180	

PP MALE ADAPTER

ITEM NO.:F11

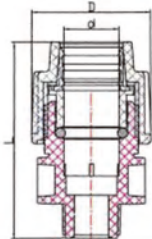

Size	Nom	d	D	L
20	21	44	75	
25	26	56	92	
32	33	65	104	
40	41	80	135	
50	51	92	148	
63	64	114	158	
75	76	128	186	
90	91	152	205	
110	111	182	226	

PP TEE

ITEM NO.:F12

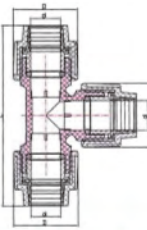

Size	Nom	d	D	L
20	21	44	125	
25	26	56	158	
32	33	65	189	
40	41	80	239	
50	51	92	262	
63	64	114	303	
75	76	128	365	
90	91	152	420	
110	111	182	482	

PP REDUCING COUPLING

ITEM NO.:F13

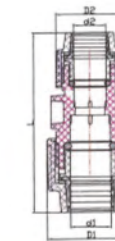

Size	Nom	d1	d2	D1	D2	L
25x20	26	21	56	44	117	
32x20	33	21	65	44	129	
32x25	33	26	65	56	143	
40x25	41	26	80	56	168	
40x32	41	33	80	65	174	
50x25	51	26	92	56	180	
50x32	51	33	92	65	188	
50x40	51	41	92	80	207	
63x32	64	33	114	65	198	
63x40	64	41	114	80	214	
63x50	64	51	114	92	227	
75x50	76	51	128	92	250	
75x63	76	64	128	114	256	
90x63	91	64	152	114	275	
90x75	91	76	152	128	295	
110x90	111	91	182	152	332	

PP MALE ELBOW

ITEM NO.:F14

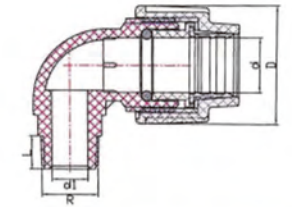

Size	Nom	d	d1	D	R	L
20x1/2"	21	12	44	1/2"	14	
25x3/4"	26	17	56	3/4"	16	
32x1"	33	22	65	1"	19	
40x1-1/4"	41	30	80	1-1/4"	21	
50x1-1/2"	51	34	92	1-1/2"	21	
63x2"	64	46	114	2"	26	
75x2-1/2"	76	59	128	2-1/2"	30	
90x3"	91	70	152	3"	33	
110x4"	111	89	182	4"	38	

PP REDUCING TEE

ITEM NO.:F15

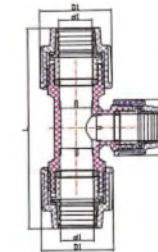

Size	Nom	d1	d2	D1	D2	L
25x20x25	26	21	56	44	158	
32x20x32	33	21	65	44	179.5	
32x25x32	33	26	65	56	189	
40x25x40	41	26	80	56	228	
40x32x40	41	33	80	65	239	
50x25x50	51	26	92	56	254	
50x32x50	51	33	92	65	262	
50x40x50	51	41	92	80	262	
63x50x63	64	51	114	92	303	
75x50x75	76	51	128	92	365	
75x63x75	76	64	128	114	365	
90x63x90	91	64	152	114	420	
90x75x90	91	76	152	128	420	
110x90x110	111	91	182	152	482	

PP COMPRESSION VALVE

ITEM NO.:F16

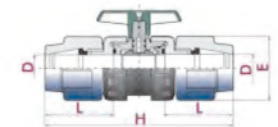

Size	Nom	D	E	L	H
1/2"	31	43.7	31	137	
3/4"	35.5	43.7	32.5	141	
1"	41	55.1	35	148	
1-1/4"	50	79	47	195	
1-1/2"	63	92	41	205	
2"	75	105	52	226	

EQUAL TEE

ITEM NO.:F18

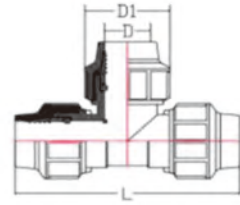

Size	Nom	D	DN	PN	E(mm)	L(mm)
20	20	15	16	46	90	
25	25	20	16	55	110	
32	32	25	16	63	120	
40	40	32	16	80	140	
50	50	40	16	96	168	
63	63	50	16	115	204	
75	75	65	10	129	242	
90	90	80	10	155	270	
110	110	100	10	184	380	

REDUCER

ITEM NO.:F19

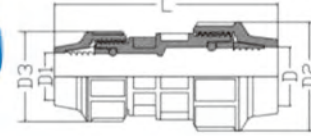

Size	Nom	DXD1(mm)	DN	PN	D2(mm)	L(mm)	D3(mm)
25X20	25X20	20	16	55	130	46	
32X20	32X20	25	16	63	132	46	
32X25	32X25	25	16	63	138	55	
40X25	40X25	32	16	80	160	55	
40X32	40X32	32	16	80	165	63	
50X25	50X25	40	16	96	173	55	
50X32	50X32	40	16	96	182	63	
50X40	50X40	40	16	96	200	80	
63X32	63X32	50	16	115	202	63	
63X40	63X40	50	16	115	214	80	
63X50	63X50	50	16	115	240	96	
75X50	75X50	65	10	129	268	96	
75X63	75X63	65	10	129	293	115	
90X63	90X63	80	10	155	304	115	
90X75	90X75	80	10	155	328	129	
110X75	110X75	100	10	184	373	129	
110X90	110X90	100	10	184	380	155	

REDUCING TEE

ITEM NO.:F20



Size	Nom	D	DN	PN	E(mm)	L(mm)
25X20X25	25X20X25	20	16	55	164	
32X20X32	32X20X32	25	16	63	190	
32X25X32	32X25X32	25	16	63	190	
40X25X40	40X25X40	32	16	80	218	
40X32X40	40X32X40	32	16	80	218	
50X25X50	50X25X50	40	16	96	268	
50X32X50	50X32X50	40	16	96	268	
50X40X50	50X40X50	40	16	96	268	
63X32X60	63X32X60	50	16	115	334	
63X40X63	63X40X63	50	16	115	334	
63X50X60	63X50X60	50	16	115	334	
75X50X74	75X50X74	65	10	129	396	
75X63X75	75X63X75	65	10	129	396	
90X63X90	90X63X90	80	10	155	440	
90X75X90	90X75X90	80	10	155	440	
110X90X110	110X90X110	100	10	184	556	

MALE TEE

ITEM NO.:F21



Size	Nom	D(mm)	DN	PN	D1(mm)	L(mm)	L1(mm)	M
20X1/2"	20	15X15	16	46	140	16	1/2"	
20X3/4"	20	15X20	16	46	140	18	3/4"	
25X1/2"	25	20X15	16	55	164	16	1/2"	
25X3/4"	25	20X20	16	55	164	18	3/4"	
25X1"	25	20X25	16	55	164	20	1"	
32X1/2"	32	25X15	16	63	190	16	1/2"	
32X3/4"	32	25X20	16	63	190	18	3/4"	
32X1"	32	25X25	16	63	190	20	1"	
32X1-1/4"	32	25X32	16	63	190	25	1-1/4"	
40X1"	40	32X25	16	80	218	20	1"	
40X1-1/4"	40	32X32	16	80	218	25	1-1/4"	
40X1-1/2"	40	32X40	16	80	218	27	1-1/2"	
50X1-1/4"	50	40X32	16	96	268	25	1-1/4"	
50X1-1/2"	50	40X40	16	96	268	27	1-1/2"	
50X2"	50	40X50	16	96	268	30	2"	
63X1-1/4"	63	50X32	16	115	334	25	1-1/4"	
63X1-1/2"	63	50X40	16	115	334	27	1-1/2"	
63X2"	63	50X50	16	115	334	30	2"	
63X2-1/2"	63	50X65	16	115	334	33	2-1/2"	
75X2"	75	65X50	10	129	396	30	2"	
75X2-1/2"	75	65X65	10	129	396	33	2-1/2"	
75X3"	75	65X80	10	129	396	35	3"	
90X3"	90	80X80	10	155	440	35	3"	
90X4"	90	80X100	10	155	440	40	4"	
110X3"	110	100X80	10	184	556	40	3"	
110X4"	110	100X100	10	184	556	35	4"	

COUPLING

ITEM NO.:F22

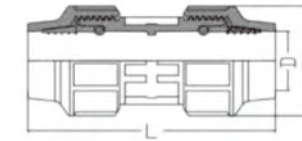

Size	Nom	D	DN	PN	D1(mm)	L(mm)
20	20	15	16	46	110	
25	25	20	16	55	126	
32	32	25	16	63	136	
40	40	32	16	80	164	
50	50	40	16	96	204	
63	63	50	16	115	246	
75	75	65	16	129	290	
90	90	80	16	155	320	
110	110	100	16	184	410	

FEMALE TEE

ITEM NO.:F23

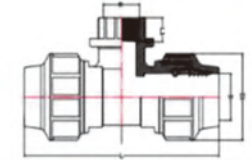

Size	Nom	D(mm)	DN	PN	D1(mm)	L(mm)	L1(mm)	M
20X1/2"	20	15X15	16	46	140	16	1/2"	
20X3/4"	20	15X20	16	46	140	18	3/4"	
25X1/2"	25	20X15	16	55	164	16	1/2"	
25X3/4"	25	20X20	16	55	164	18	3/4"	
25X1"	25	20X25	16	55	164	20	1"	
32X1/2"	32	25X15	16	63	190	16	1/2"	
32X3/4"	32	25X20	16	63	190	18	3/4"	
32X1"	32	25X25	16	63	190	20	1"	
32X1-1/4"	32	25X32	16	63	190	25	1-1/4"	
40X1"	40	32X25	16	80	218	20	1"	
40X1-1/4"	40	32X32	16	80	218	25	1-1/4"	
40X1-1/2"	40	32X40	16	80	218	27	1-1/2"	
50X1-1/4"	50	40X32	16	96	268	25	1-1/4"	
50X1-1/2"	50	40X40	16	96	268	27	1-1/2"	
50X2"	50	40X50	16	96	268	30	2"	
63X1-1/2"	63	50X40	16	115	334	27	1-1/2"	
63X2"	63	50X50	16	115	334	30	2"	
63X2-1/2"	63	50X65	16	115	334	33	2-1/2"	
75X2"	75	65X50	10	129	396	30	2"	
75X2-1/2"	75	65X65	10	129	396	33	2-1/2"	
75X3"	75	65X80	10	129	396	35	3"	
90X3"	90	80X80	10	155	440	35	3"	
90X4"	90	80X100	10	155	440	40	4"	
110X3"	110	100X80	10	184	556	35	3"	
110X4"	110	100X100	10	184	556	40	4"	

FEMALE ADAPTER

ITEM NO.:F24

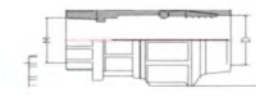

Size	Nom	D(mm)	DN	PN	D1(mm)	L(mm)	L1(mm)	M
20X1/2"	20	15X15	16	46	73	16	1/2"	
20X3/4"	20	15X20	16	46	75	18	3/4"	
20X1"	20	15X25	16	46	77	20	1"	
25X1/2"	25	20X15	16	55	84	16	1/2"	
25X3/4"	25	20X20	16	55	86	18	3/4"	
25X1"	25	20X25	16	55	88	20	1"	
32X3/4"	32	25X20	16	63	92	18	3/4"	
32X1"	32	25X25	16	63	94	20	1"	
32X1-1/4"	32	25X32	16	63	99	25	1-1/4"	
40X1"	40	32X25	16	80	108	20	1"	
40X1-1/4"	40	32X32	16	80	113	25	1-1/4"	
40X1-1/2"	40	32X40	16	80	115	27	1-1/2"	
50X1-1/4"	50	40X32	16	96	131	25	1-1/4"	
50X1-1/2"	50	40X40	16	96	133	27	1-1/2"	
50X2"	50	40X50	16	96	135	30	2"	
63X1-1/4"	63	50X32	16	115	149	25	1-1/4"	
63X1-1/2"	63	50X40	16	115	151	27	1-1/2"	
63X2"	63	50X50	16	115	154	30	2"	
63X2-1/2"	63	50X65	16	115	157	33	2-1/2"	
75X1-1/2"	75	65X40	10	129	180	27	1-1/2"	
75X2"	75	65X50	10	129	183	30	2"	
75X2-1/2"	75	65X65	10	129	186	33	2-1/2"	
75X3"	75	65X80	10	129	188	35	3"	
90X2"	90	80X50	10	155	196	30	2"	
90X2-1/2"	90	80X65	10	155	199	33	2-1/2"	
90X3"	90	80X80	10	155	301	35	3"	

MALE ELBOW

ITEM NO.:F25

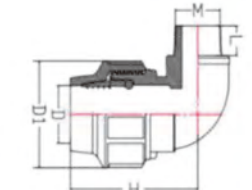

Size	Nom	D(mm)	DN	PN	D1(mm)	H(mm)	L1(mm)	M
20X1/2"	20X1/2"	15X15	16	46	70	16	1/2"	
20X3/4"	20X3/4"	15X20	16	46	70	18	3/4"	
25X1/2"	25X1/2"	20X15	16	55	82	16	1/2"	
25X3/4"	25X3/4"	20X20	16	55	82	18	3/4"	
25X1"	25X1"	20X25	16	55	82	20	1"	
32X1/2"	32X1/2"	25X15	16	63	95	16	1/2"	
32X3/4"	32X3/4"	25X20	16	63	95	18	3/4"	
32X1"	32X1"	25X25	16	63	95	20	1"	
32X1-1/4"	32X1-1/4"	25X32	16	63	95	25	1-1/4"	
40X1"	40X1"	32X25	16	80	109	20	1"	
40X1-1/4"	40X1-1/4"	32X32	16	80	109	25	1-1/4"	
40X1-1/2"	40X1-1/2"	32X40	16	80	109	27	1-1/2"	
50X1-1/4"	50X1-1/4"	40X32	16	96	134	25	1-1/4"	
50X1-1/2"	50X1-1/2"	40X40	16	96	134	27	1-1/2"	
50X2"	50X2"	40X50	16	96	134	30	2"	
63X1-1/4"	63X1-1/4"	50X32	16	115	167	25	1-1/4"	
63X1-1/2"	63X1-1/2"	50X40	16	115	167	27	1-1/2"	
63X2"	63X2"	50X50	16	115	167	30	2"	
63X2-1/2"	63X2-1/2"	50X65	16	115	167	33	2-1/2"	
75X2"	75X2"	65X40	10	129	198	30	2"	
75X2-1/2"	75							

90DEG ELBOW

ITEM NO.:F26

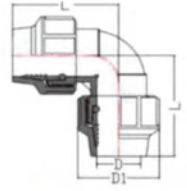

Size	Nom	D	DN	PN	D1(mm)	L(mm)
20	20	15	16	46	45	
25	25	20	16	55	55	
32	32	25	16	63	60	
40	40	32	16	80	70	
50	50	40	16	96	84	
63	63	50	16	115	102	
75	75	65	10	129	121	
90	90	80	10	155	135	
110	110	100	10	184	190	

MALE ADAPTER

ITEM NO.:F27

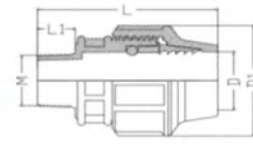

Size	Nom	D(mm)	DN	PN	D1(mm)	L(mm)	L1(mm)	M
20X1/2"	20	15X15	16	46	83	16	1/2"	
20X3/4"	20	15X20	16	46	85	18	3/4"	
20X1"	20	15X25	16	46	87	20	1"	
25X1/2"	25	20X15	16	55	91	16	1/2"	
25X3/4"	25	20X20	16	55	93	18	3/4"	
25X1"	25	20X25	16	55	95	20	1"	
32X3/4"	32	25X20	16	63	98	18	3/4"	
32X1"	32	25X25	16	63	100	20	1"	
32X1-1/4"	32	25X32	16	63	105	25	1-1/4"	
40X1"	40	32X25	16	80	103	20	1"	
40X1-1/4"	40	32X32	16	80	108	25	1-1/4"	
40X1-1/2"	40	32X40	10	80	110	27	1-1/2"	
50X1"	50	40X25	10	96	125	20	1"	
50X1-1/4"	50	40X32	10	96	130	25	1-1/4"	
50X1-1/2"	50	40X40	10	96	132	27	1-1/2"	
50X2"	50	40X50	10	96	135	30	2"	
63X1-1/4"	63	50X32	10	115	145	25	1-1/4"	
63X1-1/2"	63	50X40	16	115	150	27	1-1/2"	
63X2"	63	50X50	16	115	153	30	2"	
63X2-1/2"	63	50X65	16	115	156	33	2-1/2"	
75X1-1/2"	75	65X40	10	129	178	27	1-1/2"	
75X2"	75	65X50	10	129	180	30	2"	
75X2-1/2"	75	65X65	10	129	183	33	2-1/2"	
75X3"	75	65X80	10	129	185	35	3"	
90X2"	90	80X50	10	155	198	30	2"	
90X2-1/2"	90	80X65	10	155	200	33	2-1/2"	
90X3"	90	80X80	10	155	201	35	3"	
90X4"	90	80X100	10	155	206	40	4"	
110X2-1/2"	110	100X65	10	184	243	33	2-1/2"	
110X3"	110	100X80	10	184	245	35	3"	
110X4"	110	100X100	10	184	250	40	4"	

FEMALE ELBOW

ITEM NO.:F28

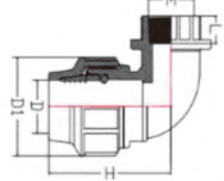

Size	Nom	D(mm)	DN	PN	D1(mm)	H(mm)	L1(mm)	M
20X1/2"	20	15X15	16	46	70	16	1/2"	
20X3/4"	20	15X20	16	46	70	18	3/4"	
25X1/2"	25	20X15	16	55	82	16	1/2"	
25X3/4"	25	20X20	16	55	82	18	3/4"	
25X1"	25	20X25	16	55	82	20	1"	
32X1/2"	32	25X15	16	63	95	16	1/2"	
32X3/4"	32	25X20	16	63	95	18	3/4"	
32X1"	32	25X25	16	63	95	20	1"	
32X1-1/4"	32	25X32	16	63	95	25	1-1/4"	
40X1"	40	32X25	16	80	109	20	1"	
40X1-1/4"	40	32X32	16	80	109	25	1-1/4"	
40X1-1/2"	40	32X40	16	80	109	27	1-1/2"	
50X1-1/4"	50	40X32	16	96	134	25	1-1/4"	
50X1-1/2"	50	40X40	16	96	134	27	1-1/2"	
50X2"	50	40X50	16	96	134	30	2"	
63X1-1/2"	63	50X40	16	115	167	27	1-1/2"	
63X2"	63	50X50	16	115	167	30	2"	
63X2-1/2"	63	50X65	16	115	167	33	2-1/2"	
75X2"	75	65X50	10	129	198	30	2"	
75X2-1/2"	75	65X65	10	129	198	33	2-1/2"	
75X3"	75	65X80	10	129	198	35	3"	
90X3"	90	80X80	10	155	220	35	3"	
90X4"	90	80X100	10	155	220	40	4"	
110X3"	110	100X80	10	184	278	35	3"	
110X4"	110	100X100	10	184	278	40	4"	

END CAP

ITEM NO.:F29

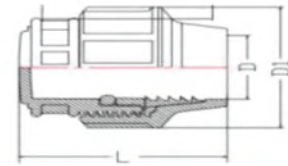

Size	Nom	D	DN	PN	D1(mm)	L(mm)
20	20	15	16	46	56	
25	25	20	16	55	66	
32	32	25	16	63	87	
40	40	32	16	80	90	
50	50	40	16	96	105	
63	63	50	16	115	124	
75	75	65	10	129	153	
90	90	80	10	155	166	
110	110	100	10	184	210	

EQUAL TEE

ITEM NO.:F30

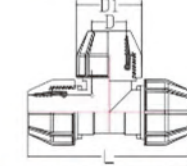

Size	Nom	D	DN	PN	E(mm)	L(mm)
20	20	15	16	46	90	
25	25	20	16	55	110	
32	32	25	16	63	120	
40	40	32	16	80	140	
50	50	40	16	96	168	
63	63	50	16	115	204	
75	75	65	10	129	242	
90	90	80	10	155	270	
110	110	100	10	184	380	

COUPLING

ITEM NO.:F34

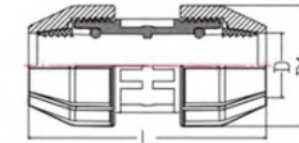

Size	Nom	D	DN	PN	D1(mm)	L(mm)
20	20	15	16	46	110	
25	25	20	16	55	126	
32	32	25	16	63	136	
40	40	32	16	80	164	
50	50	40	16	96	204	
63	63	50	16	115	246	
75	75	65	16	129	290	
90	90	80	16	155	320	
110	110	100	16	184	410	

REDUCING TEE

ITEM NO.:F31

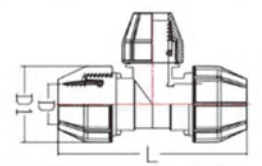

Size	Nom	D	DN	PN	E(mm)	L(mm)
25X20X25	25X20X25	20	16	55	164	
32X20X32	32X20X32	25	16	63	190	
32X25X32	32X25X32	25	16	63	190	
40X25X40	40X25X40	32	16	80	218	
40X32X40	40X32X40	32	16	80	218	
50X25X50	50X25X50	40	16	96	268	
50X32X50	50X32X50	40	16	96	268	
50X40X50	50X40X50	40	16	96	268	
63X32X60	63X32X60	50	16	115	334	
63X40X63	63X40X63	50	16	115	334	
63X50X60	63X50X60	50	16	115	334	
75X50X74	75X50X74	65	10	129	396	
75X63X75	75X63X75	65	10	129	396	
90X63X90	90X63X90	80	10	155	440	
90X75X90	90X75X90	80	10	155	440	
110X90X110	110X90X110	100	10	184	556	

REDUCER

ITEM NO.:F36

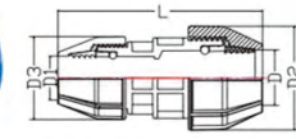

Size	Nom	DxD1(mm)	DN	PN	D2(mm)	L(mm)	D3(mm)
25X20	25X20	20	16	55	130	46	
32X20	32X20	25	16	63	132	46	
32X25	32X25	25	16	63	138	55	
40X25	40X25	32	16	80	160	55	
40X32	40X32	32	16	80	165	63	
50X25	50X25	40	16	96	173	55	
50X32	50X32	40	16	96	182	63	
50X40	50X40	40	16	96	200	80	
63X32	63X32	50	16	115	202	63	
63X40	63X40	50	16	115	214	80	
63X50	63X50	50	16	115	240	96	
75X50	75X50	65	10	129	268	96	
75X63	75X63	65	10	129	293	115	
90X63	90X63	80	10	155	304	115	
90X75	90X75	80	10	155	328	129	
110X75	110X75	100	10	184	373	129	
110X90	110X90	100	10	184	380	155	

90DEG ELBOW

ITEM NO.:F37

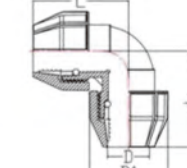

Size	Nom	D	DN	PN	D1(mm)	L(mm)
20	20	15	16	46	45	
25	25	20	16	55	55	
32	32	25	16	63	60	
40	40	32	16	80	70	
50	50	40	16	96	84	
63	63	50	16	115	102	
75	75	65	10	129	121	
90	90	80	10	155	135	
110	110	100	10	184	190	

END CAP

ITEM NO.:F38

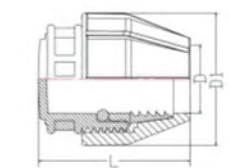

Size	Nom	D	DN	PN	D1(mm)	L(mm)
20	20	15	16	46	56	
25	25	20	16	55	66	
32	32	25	16	63	87	
40	40	32	16	80	90	
50	50	40	16	96	105	
63	63	50	16	115	124	
75	75	65	10	129	153	
90	90	80	10	155	166	
110	110	100	10	184	210	

**MALE TEE**

ITEM NO.:F32

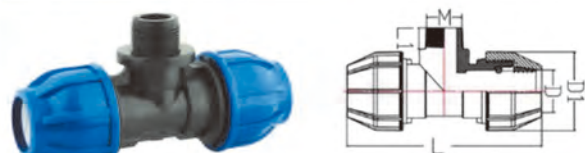

Size	Nom	D(mm)	DN	PN	D1(mm)	L(mm)	L1(mm)	M
20X1/2"	20	15X15	16	46	140	16	1/2"	
20X3/4"	20	15X20	16	46	140	18	3/4"	
25X1/2"	25	20X15	16	55	164	16	1/2"	
25X3/4"	25	20X20	16	55	164	18	3/4"	
25X1"	25	20X25	16	55	164	20	1"	
32X1/2"	32	25X15	16	63	190	16	1/2"	
32X3/4"	32	25X20	16	63	190	18	3/4"	
32X1"	32	25X25	16	63	190	20	1"	
32X1-1/4"	32	25X32	16	63	190	25	1-1/4"	
40X1"	40	32X25	16	80	218	20	1"	
40X1-1/4"	40	32X32	16	80	218	25	1-1/4"	
40X1-1/2"	40	32X40	16	80	218	27	1-1/2"	
50X1-1/4"	50	40X32	16	96	268	25	1-1/4"	
50X1-1/2"	50	40X40	16	96	268	27	1-1/2"	
50X2"	50	40X50	16	96	268	30	2"	
63X1-1/4"	63	50X32	16	115	334	25	1-1/4"	
63X1-1/2"	63	50X40	16	115	334	27	1-1/2"	
63X2"	63	50X50	16	115	334	30	2"	
63X2-1/2"	63	50X65	16	115	334	33	2-1/2"	
75X2"	75	65X50	10	129	396	30	2"	
75X2-1/2"	75	65X65	10	129	396	33	2-1/2"	
75X3"	75	65X80	10	129	396	35	3"	
90X3"	90	80X80	10	155	440	35	3"	
90X4"	90	80X100	10	155	440	40	4"	
110X3"	110	100X80	10	184	556	40	3"	
110X4"	110	100X100	10	184	556	35	4"	

**MALE ADAPTER**

ITEM NO.:F35

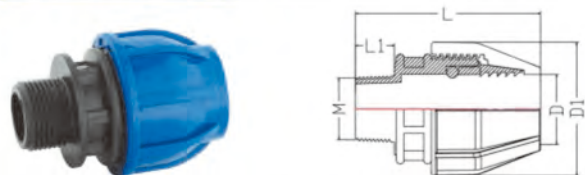

Size	Nom	D(mm)	DN	PN	D1(mm)	L(mm)	L1(mm)	M
20X1/2"	20	15X15	16	46	83	16	1/2"	
20X3/4"	20	15X20	16	46	85	18	3/4"	
20X1"	20	15X25	16	46	87	20	1"	
25X1/2"	25	20X15	16	55	91	16	1/2"	
25X3/4"	25	20X20	16	55	93	18	3/4"	
25X1"	25	20X25	16	55	95	20	1"	
32X3/4"	32	25X20	16	63	98	18	3/4"	
32X1"	32	25X25	16	63	100	20	1"	
32X1-1/4"	32	25X32	16	63	105	25	1-1/4"	
40X1"	40	32X25	16	80	103	20	1"	
40X1-1/4"	40	32X32	16	80	108	25	1-1/4"	
40X1-1/2"	40	32X40	16	80	110	27	1-1/2"	
50X1"	50	40X25	16	96	125	20	1"	
50X1-1/4"	50	40X32	16	96	130	25	1-1/4"	
50X1-1/2"	50	40X40	16	96	132	27	1-1/2"	
50X2"	50	40X50	16	96	135	30	2"	
63X1-1/4"	63	50X32	16	115	145	25	1-1/4"	
63X1-1/2"	63	50X40	16	115	150	27	1-1/2"	
63X2"	63	50X50	16	115	153	30	2"	
63X2-1/2"	63	50X65	16	115	156	33	2-1/2"	
75X1-1/2"	75	65X40	10	129	178	27	1-1/2"	
75X2"	75	65X50	10	129	180	30	2"	
75X2-1/2"	75	65X65	10	129	183	33	2-1/2"	
75X3"	75	65X80	10	129	185	35	3"	
90X2"	90	80X50	10	155	198	30	2"	
90X2-1/2"	90	80X65	10	155	200	33	2-1/2"	
90X3"	90	80X80	10	155	201	35	3"	
90X4"	90	80X100	10	155	206	40	4"	
110X2-1/2"	110	100X65	10	184	243	33	2-1/2"	
110X3"	110	100X80	10	184	245	35	3"	
110X4"	110	100X100	10	184	250	40	4"	

**MALE ELBOW**

ITEM NO.:F33

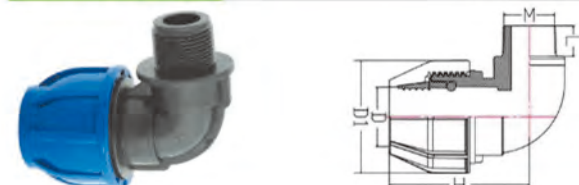

Size	Nom	D(mm)	DN	PN	D1(mm)	H(mm)	L1(mm)	M
20X1/2"	20X1/2"	15X15	16	46	70	16	1/2"	
20X3/4"	20X3/4"	15X20	16	46	70	18	3/4"	
25X1/2"	25X1/2"	20X15	16	55	82	16	1/2"	
25X3/4"	25X3/4"	20X20	16	55	82	18	3/4"	
25X1"	25X1"	20X25	16	55	82	20	1"	
32X1/2"	32X1/2"	25X15	16	63	95	16	1/2"	
32X3/4"	32X3/4"	25X20	16	63	95	18	3/4"	
32X1"	32X1"	25X25	16	63	95	20	1"	
32X1-1/4"	32X1-1/4"	25X32	16	63	95	25	1-1/4"	
40X1"	40X1"	32X25	16	80	109	20	1"	
40X1-1/4"	40X1-1/4"	32X32	16	80	109	25	1-1/4"	
40X1-1/2"	40X1-1/2"	32X40	16	80	109	27	1-1/2"	
50X1-1/4"	50X1-1/4"	40X32	16	96	134	25	1-1/4"	
50X1-1/2"	50X1-1/2"	40X40	16	96	134	27	1-1/2"	
50X2"	50X2"	40X50	16	96	134	30	2"	
63X1-1/4"	63X1-1/4"	50X32	16	115	167	25	1-1/4"	
63X1-1/2"	63X1-1/2"	50X40	16	115	167	27	1-1/2"	
63X2"	63X2"	50X50	16	115	167	30	2"	
63X2-1/2"	63X2-1/2"	50X65	16	115	167	33	2-1/2"	
75X2"	75X2"	65X40	10	129	198	30	2"	
75X2-1/2"	75X2-1/2"	65X65	10	129	198	33	2-1/2"	
75X3"	75X3"	65X80	10	129	198	35	3"	
90X3"	90X3"	80X80	10	155	220	35	3"	
90X4"	90X4"	80X100	10	155	220	40	4"	
110X3"	110X3"	100X80	10	184	278	40	3"	
110X4"	110X4"	100X100	10	184	278	35	4"	

**FEMALE ADAPTER**

ITEM NO.:F40



Size	Nom	D(mm)	DN	PN	D1(mm)	L(mm)	L1(mm)	M
20X1/2"	20	15X15	16	46	73	16	1/2"	
20X3/4"	20	15X20	16	46	75	18	3/4"	
20X1"	20	15X25	16	46	77	20	1"	
25X1/2"	25	20X15	16	55	84	16	1/2"	
25X3/4"	25	20X20	16	55	86	18	3/4"	
25X1"	25	20X25	16	55	88	20	1"	
32X3/4"	32	25X20	16	63	92	18	3/4"	
32X1"	32	25X25	16	63	94	20	1"	
32X1-1/4"	32	25X32	16	63	99	25	1-1/4"	
40X1"	40	32X25	16	80	108	20	1"	
40X1-1/4"	40	32X32	16	80	113	25	1-1/4"	
40X1-1/2"	40	32X40	16	80	115	27	1-1/2"	
50X1-1/4"	50	40X32	16	96	131	25	1-1/4"	
50X1-1/2"	50	40X40	16	96	133	27	1-1/2"	
50X2"	50	40X50	16	96	135	30	2"	
63X1-1/4"	63	50X32	16	115	149	25	1-1/4"	
63X1-1/2"	63	50X40	16	115	151	27	1-1/2"	
63X2"	63	50X50	16	115	154	30	2"	
63X2-1/2"	63	50X65	16	115	157	33	2-1/2"	
75X1-1/2"	75	65X40	10	129	180	27	1-1/2"	
75X2"	75	65X50	10	129	183	30	2"	
75X2-1/2"	75	65X65	10	129	186	33	2-1/2"	
75X3"	75	65X80	10	129	188	35	3"	
90X2"	90	80X50	10	155	196	30	2"	
90X2-1/2"	90	80X65	10	155	199	33	2-1/2"	
90X3"	90	80X80	10	155	301	35	3"	

**FEMALE ELBOW**

ITEM NO.:F41



Size	Nom	D(mm)	DN	PN	D1(mm)	H(mm)	L1(mm)	M
20X1/2"	20	15X15	16	46	70	16	1/2"	
20X3/4"	20	15X20	16	46	70	18	3/4"	
25X1/2"	25	20X15	16	55	82	16	1/2"	
25X3/4"	25	20X20	16	55	82	18	3/4"	
25X1"	25	20X25	16	55	82	20	1"	
32X1/2"	32	25X15	16	63	95	16	1/2"	
32X3/4"	32	25X20	16	63	95	18	3/4"	
32X1"	32	25X25	16	63	95	20	1"	
32X1-1/4"	32	25X32	16	63	95	25	1-1/4"	
40X1"	40	32X25	16	80	109	20	1"	
40X1-1/4"	40	32X32	16	80	109	25	1-1/4"	
40X1-1/2"	40	32X40	16	80	109	27	1-1/2"	
50X1-1/4"	50	40X32	16	96	134	25	1-1/4"	
50X1-1/2"	50	40X40	16	96	134	27	1-1/2"	
50X2"	50	40X50	16	96	134	30	2"	
63X1-1/2"	63	50X40	16	115	167	27	1-1/2"	
63X2"	63	50X50	16	115	167	30	2"	
63X2-1/2"	63	50X65	16	115	167	33	2-1/2"	
75X2"	75	65X50	10	129	198	30	2"	
75X2-1/2"	75	65X65	10	129	198	33	2-1/2"	
75X3"	75	65X80	10	129	198	35	3"	
90X3"	90	80X80	10	155	220	35	3"	
90X4"	90	80X100	10	155	220	40	4"	
110X3"	110	100X80	10	184	278	40	3"	
110X4"	110	100X100	10	184	278	40	4"	

**FEMALE TEE**

ITEM NO.:F42



Size	Nom	D(mm)	DN	PN	D1(mm)	L(mm)	L1(mm)	M
20X1/2"	20	15X15	16	46	140	16	1/2"	
20X3/4"	20	15X20	16	46	140	18	3/4"	
25X1/2"	25	20X15	16	55	164	16	1/2"	
25X3/4"	25	20X20	16	55	164	18	3/4"	
25X1"	25	20X25	16	55	164	20	1"	
32X1/2"	32	25X15	16	63	190	16	1/2"	
32X3/4"	32	25X20	16	63	190	18	3/4"	
32X1"	32	25X25	16	63	190	20	1"	
32X1-1/4"	32	25X32	16	63	190	25	1-1/4"	
40X1"	40	32X25	16	80	218	20	1"	
40X1-1/4"	40	32X32	16	80	218	25	1-1/4"	
40X1-1/2"	40	32X40	16	80	218	27	1-1/2"	
50X1-1/4"	50	40X32	16	96	268	25	1-1/4"	
50X1-1/2"	50	40X40	16	96	268	27	1-1/2"	
50X2"	50	40X50	16	96	268	30	2"	
63X1-1/2"	63	50X40	16	115	334	27	1-1/2"	
63X2"	63	50X50	16	115	334	30	2"	
63X2-1/2"	63							

# PVC VALVES



## PVC COMPACT BALL VALVE (SOCKET/THREAD)

ITEM NO.:E01

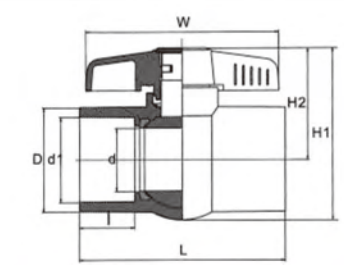

Size	Nom	DIN d1	ANSI d1	BS d1	d	D	I	L	H1	H2	W
1/2"	20	21.3	22	14.5	32	22	80	64.3	44.9	68.5	
3/4"	25	26.7	26	20	36.8	25	92	76	52	80.5	
1"	32	33.4	34	24	45	28	106	94	65	100	
1-1/4"	40	42.2	42	30	53.5	28	112.5	103	70	108	
1-1/2"	50	48.3	48	34	62	33	129	112	73.5	108	
2"	63	60.3	60	44	75.5	39.5	148	126	81	138	
2-1/2"	75	73	76	56	92.5	39.5	177.5	166	108.5	192.5	
3"	90	88.9	89	71	107	48	209	181	116	192.5	
4"	110	114.3	114	86	134.5	78	294	236	151.5	262	

## PVC OCTAGONAL BALL VALVE (SOCKET/THREAD)

ITEM NO.:E02

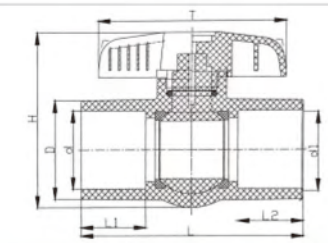

Size	Nom	DIN d1	ANSI d1	BS d1	d	D	L	L1	L2	H	T
1/2"	20	21.3	22	14.5	32	69.8	18.2	18	60.1	65	
3/4"	25	26.7	26	20	36.8	79.2	22	22	69.5	71.8	
1"	32	33.4	34	24	45	94.2	26.2	25	83.7	87.8	
1-1/4"	40	42.2	42	30	53.5	106.8	26.8	26	94.5	99.6	
1-1/2"	50	48.3	48	34	62	122.8	31.2	31	109.7	109.8	
2"	63	60.3	60	44	75.5	142.7	34.5	34	129	127.5	
2-1/2"	75	73	76	56	92.5	173	41.5	41.5	164.5	180	
3"	90	88.9	89	71	107	228	65	62	191	196	
4"	110	114.3	114	86	134.5	256	65.5	65.5	216	218.5	

## PVC DOUBLE UNION BALL VALVE (SOCKET/THREAD)

ITEM NO.:E03

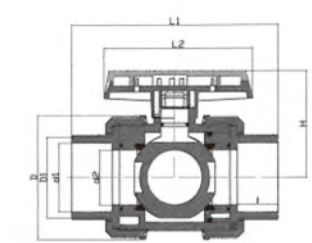

Size	Nom	DIN d1	ANSI d1	BS d1	d2	D	D1	I	L1	L2	H
1/2"	20	21.3	22	14	51.2	27.6	20.6	112.5	65	50.5	
3/4"	25	26.7	26	18.7	65.5	35.6	24.6	130.2	75	58.5	
1"	32	33.4	34	24	73.7	41.6	28	142.5	85	65.7	
1-1/4"	40	42.2	42	32	86.6	52	31	161	97	76.5	
1-1/2"	50	48.3	48	40	102	59.5	31.5	166.5	110	86	
2"	63	60.3	60	50	120	75	40	214	133.5	101.5	
2-1/2"	75	73	76	60	135	87.5	40	228	161	112.5	
3"	90	88.9	89	79	188	107.5	48	269	200	160.5	
4"	110	114.3	114	99	216	132	56	309	240	173.5	

PVC SINGLE UNION BALL VALVE (SOCKET/THREAD)

ITEM NO.:E04

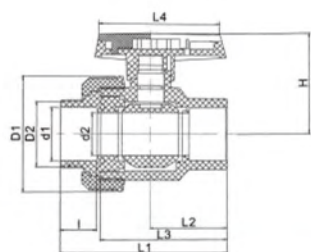

Size	Nom	DIN d1	ANSI d1	BS d1	d2	D1	D2	I	L1	L2	L3	L4	H
1/2"	20	21.3	22	22	14	51.3	27.6	20.6	95.8	25.3	67.3	65	49.5
3/4"	25	26.7	26	26	18.7	65.5	35.2	25	111.4	32.4	78.3	74.9	56.5
1"	32	33.4	34	34	24	73.7	41.6	27.9	121.5	49.5	85.9	85	65
1-1/4"	40	42.2	42	42	32	86.6	49	27	130	57	99	97.1	76.5
1-1/2"	50	48.3	48	48	40	102	60.8	34.5	157.5	69	113.5	109.7	86.5
2"	63	60.3	60	60	50	120	74.5	40	190	81	136.5	190.0	102
2-1/2"	75	73	76	76	60	135	89	40	210	95.9	156	161	113.5
3"	90	88.9	89	89	79	188	107.5	48	254.6	120.9	196.5	199.4	161.5
4"	110	114.3	114	114	99	215.5	132	56	294	140.7	225	240	174

PVC FOOT VALVE(SOCKET/THREAD)

ITEM NO.:E05

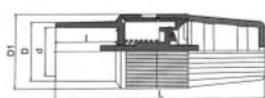

Size	Nom	DIN d1	ANSI d1	BS d1	D	D1	I	L
3/4"	25	26.7	26	26	35.5	43.7	32.5	141
1"	32	33.4	34	34	41.9	43.7	32.8	141
1-1/4"	40	42.2	42	42	51	78	35	195.3
1-1/2"	50	48.3	48	48	60.3	78	56	217.4
2"	63	60.3	60	60	72.5	78	57	217.4
2-1/2"	75	73	76	76	90	171.6	73.5	293.4
3"	90	88.9	89	89	76.4	183.8	58.2	252
4"	110	114.3	114	114	115	216	91	360
6"	160	168.3	168.3	168.3	161	291	120	500

PVC CHECK VALVE

ITEM NO.:E06

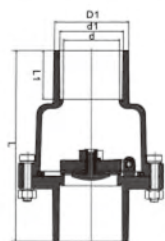

Size	Nom	DIN d1	ANSI d1	BS d1	d	D1	L	L1
2-1/2"	75	73.03	76	76	68.3	89	226.2	58
3"	90	88.9	89	89	83	103.6	264.4	73
4"	110	114.3	114	114	101	131.6	358	90
6"	160	168.3	166	166	147	182	422.4	113

PVC BUTTERFLY VALVE (HANDLE LEVER TYPE)

ITEM NO.:E07

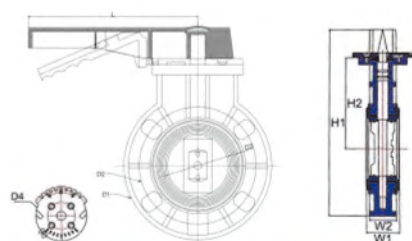

Size	Nom	D1	ANSI D2	BS D2	D3	D4	L	H1	H2	W1	W2
2"	160.1	120	120.4	120.4	55.6	99.7	189.7	223.3	98.3	44	32
2-1/2"	179.8	141.2	139.5	139.5	68.7	99.7	189	247	111.6	48.3	32.4
3"	195	156.4	139.5	139.5	83.9	99.7	238.5	282.6	132.5	51.9	36.3
4"	228.1	183	152.4	152.4	103.2	99.7	239.5	319.4	155.4	54.5	44.1
5"	257	210.9	190.5	190.5	129.5	139	309.8	368	170.3	66.5	54.6
6"	285.4	238.5	241.5	241.5	151.1	140	309.8	400.8	187.5	73.1	56.4
8"	342.6	292.4	298.5	298.5	198.6	140	309.8	473	230.1	92	72.2

PVC NEW COMPACT BALL VALVE

ITEM NO.:E08

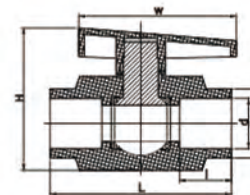

Size	Nom	d	D	I	L	H	W
1/2"	21.34	27.0	20.3	68.9	48.9	58.0	
3/4"	26.67	31.2	23.8	83.6	65.4	73.2	
1"	33.40	40.0	28.5	102.9	85.2	89.4	
1-1/4"	42.16	50.7	30.2	114.5	98.0	97.4	
1-1/2"	48.26	56.6	33.3	127.2	111.5	107.5	
2"	60.32	69.2	37.1	155.1	141.0	128.3	

PVC FOOT VALVE

ITEM NO.:E10

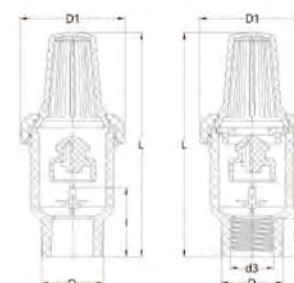

Size	Nom	d3(BSPT)	D	D1	H	I	L(mm)
1/2"	21.0	29.9	42	18.3	33.1	108	
3/4"	26.6	36.2	52	18.5	35.7	118	
1"	33.5	42	58	22	38.5	133	
1-1/4"	42.6	53	71	26	46.5	160	
1-1/2"	48.0	60.9	81	26.8	59	182	
2"	60.0	75	99	43.4	242		
3"	78	107.5	166.7	55	356.2		
4"	78	134.6	198.2	64.5	436.6		

THERMOPLASTIC CORPORATION VALVE

ITEM NO.:E20

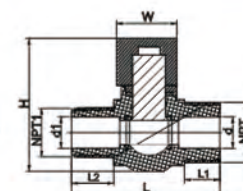

Size	Nom	d	NPT	d1	NPT1	L1	L2	L	H	W
3/4" x 1/2"	13.6	3/4"	13.8	1/2"	15.3	18.0	62.6	59.2	25.8	

PVC CHECK VALVE

ITEM NO.:E09

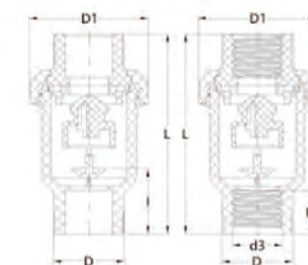

Size	Nom	d3(BSPT)	D	D1	H	I	L(mm)
1/2"	21.0	29.9	42	18.3	33.1	84	
3/4"	26.6	36.2	52	18.5	35.7	90	
1"	33.5	42	58	22	38.5	100	
1-1/4"	42.6	53	71	26	46.5	120	
1-1/2"	48.0	60.9	81	26.8	59	135	
2"	60.0	75	99	43.4	185		
3"	78	107.5	166.7	55	252.3		
4"	78	134.6	198.2	64.5	302.1		

OCTAGONAL VALVE WITH AUXILIARY OUTPUT

ITEM NO.:E15

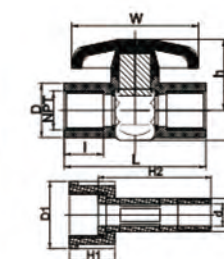

Size	Nom	d	D	D1	NPT	I	L	h	H	H1	H2	W
1/2"	15.1	30.5	37.7	1/2"	18.0	65.2	41.0	58.0	20.5	54.9	60.9	

OCTAGONAL VALVE

ITEM NO.:E21

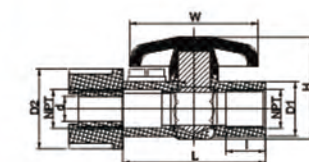

Size	Nom	d	NPT	D1	D2	L	I	H	W
1/2"	17.3	1/2"	31	38	58.7	16.1	58	60.9	

**PVC SPRING CHECK VALVE (SOCKET/THREAD)**

ITEM NO.:E22

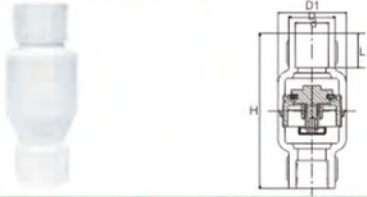

Size	Nom	D1	D	ANSI(d)	DIN(d)	L	H
1/2"	45.2	30.5	21.34	1/2"	23	103	
3/4"	45.2	35.5	26.67	3/4"	27	113.6	
1"	57.5	43	33.4	1"	28	142	
1-1/4"	79.6	52	42.16	1-1/4"	30.6	156	
1-1/2"	79.8	60.2	48.26	1-1/2"	36	167.4	
2"	103.6	72	60.33	2"	40.6	194.8	

**PVC TWO-PIECE BALL VALVE STAINLESS STEEL HANDLE (NEW)**

ITEM NO.:E24



Size	Nom	L	L1	D	R	H	T
Ø20	93.4	31	31.7	1/2"	60.7	63.5	
Ø25	98.6	31	37	3/4"	68.3	83.5	
Ø32	114.3	35	44.8	1"	78.2	83.5	
Ø40	128.9	38	57.4	1.1/4"	102	97.5	
Ø50	139.6	41	63.9	1.1/2"	115	117.3	
Ø63	167.2	48	79	2"	123.8	117.3	

**PVC TWO-PIECE BALL VALVE FULL PLASTIC HANDLE (NEW)**

ITEM NO.:E25

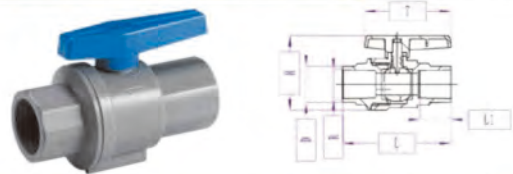

Size	Nom	L	L1	D	R	H	T
15MM(1/2")	93.4	31	31.7	1/2"	64	79	
20MM(3/4")	98.6	31	37	3/4"	70.5	79	
25MM(1")	114.3	35	44.8	1"	87.8	101.2	
32MM(1.1/4")	128.9	38	57.4	1.1/4"	99.5	101.2	
40MM(1.1/2")	139.6	41	63.9	1.1/2"	114.8	131.4	
50MM(2")	167.2	48	79	2"	128.7	131.4	

**PVC OUTER WIRE BALL VALVE**

ITEM NO.:E27



Size	Nom	D	D1	A	B	C	D	E	L	T
20MM(3/4")	20	26.4	65	78.4	85.7	35	59.4	18	16	
25MM(1")	25	33.2	73	89.8	100.5	41	68.7	19	17	
32MM(1.1/4")	30	41.9	84.5	106	111	49.8	78.6	23	21	
40MM(1.1/2")	39	47.8	93	123	133	59	94.6	24	23	
50MM(2")	49	59.6	107	144	159.5	72	114.6	28	27	
65MM(2.1/2")	60	75.2	141	173.5	191.5	89.4	139	33	31.5	
80MM(3")	76	87.9	151	201	221.5	103	168	38	36.5	
100MM(4")	96	113	175.5	237.5	267	128.2	205.6	43	41.5	

**PVC TWO-PIECE BALL VALVE STAINLESS STEEL HANDLE (ORDINARY)**

ITEM NO.:E23

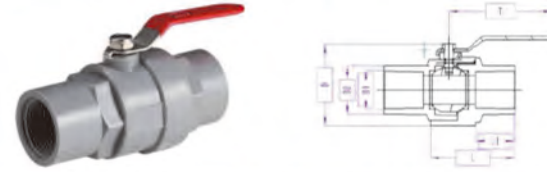

Size	Nom	L	L1	D	R	H	T
Ø20	93.3	28	29	1/2"	59.8	63.5	
Ø25	99.8	30	34.7	3/4"	66.5	83.5	
Ø32	113.6	33	42.7	1"	75.1	83.5	
Ø40	130.7	38	53.8	1.1/4"	89.9	97.5	
Ø50	139.5	40	61	1.1/2"	109.9	117.3	
Ø63	167	48	73.7	2"	119.3	117.3	
Ø75	197.6	56	91	2.1/2"	148.4	139.1	
Ø90	251.9	75	106.3	3"	178.4	190	
Ø110	282.5	76	134.4	4"	196.7	212.6	

**PVC TWO-PIECE BALL VALVE FULL PLASTIC HANDLE (ORDINARY)**

ITEM NO.:E25

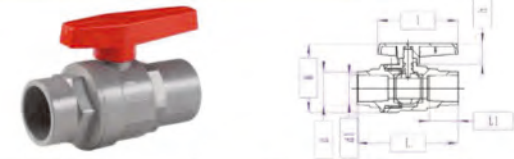

Size	Nom	L	L1	D	R	H
15MM(1/2")	93.3	28	29	1/2"	62.9	
20MM(3/4")	99.8	30	34.7	3/4"	68	
25MM(1")	113.6	33	42.7	1"	84.3	
32MM(1.1/4")	130.7	38	53.8	1.1/4"	95.4	
40MM(1.1/2")	139.5	40	61	1.1/2"	110.8	
50MM(2")	167	48	73.7	2"	125	
65MM(2.1/2")	197.6	56	91	2.1/2"	163.1	
80MM(3")	251.9	75	106.3	3"	190	
100MM(4")	282.5	76	134.4	4"	220	

**PVC INNER WIRE BALL VALVE**

ITEM NO.:E26

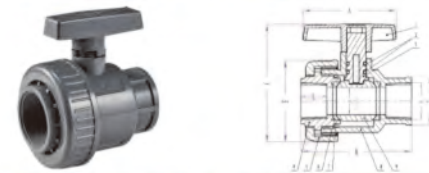

Size	Nom	D	D1	A	B	C	D	E	L
20MM(3/4")	20	26.7	65	76.9	85.7	35	59.4	18	
25MM(1")	25	33.5	73	86.8	100.5	43	68.7	19	
32MM(1.1/4")	30	42.2	84.5	103	111	52	78.6	23	
40MM(1.1/2")	39	48	93	115	133	61	94.6	24	
50MM(2")	49	59.9	107	136.4	159.5	73	114.6	28	
65MM(2.1/2")	60	75.5	141	163	191.5	91.8	139	33	
80MM(3")	76	88.2	151	192	221.5	104	168	38	
100MM(4")	96	113.4	175.5	226	267	130	205.6	43	

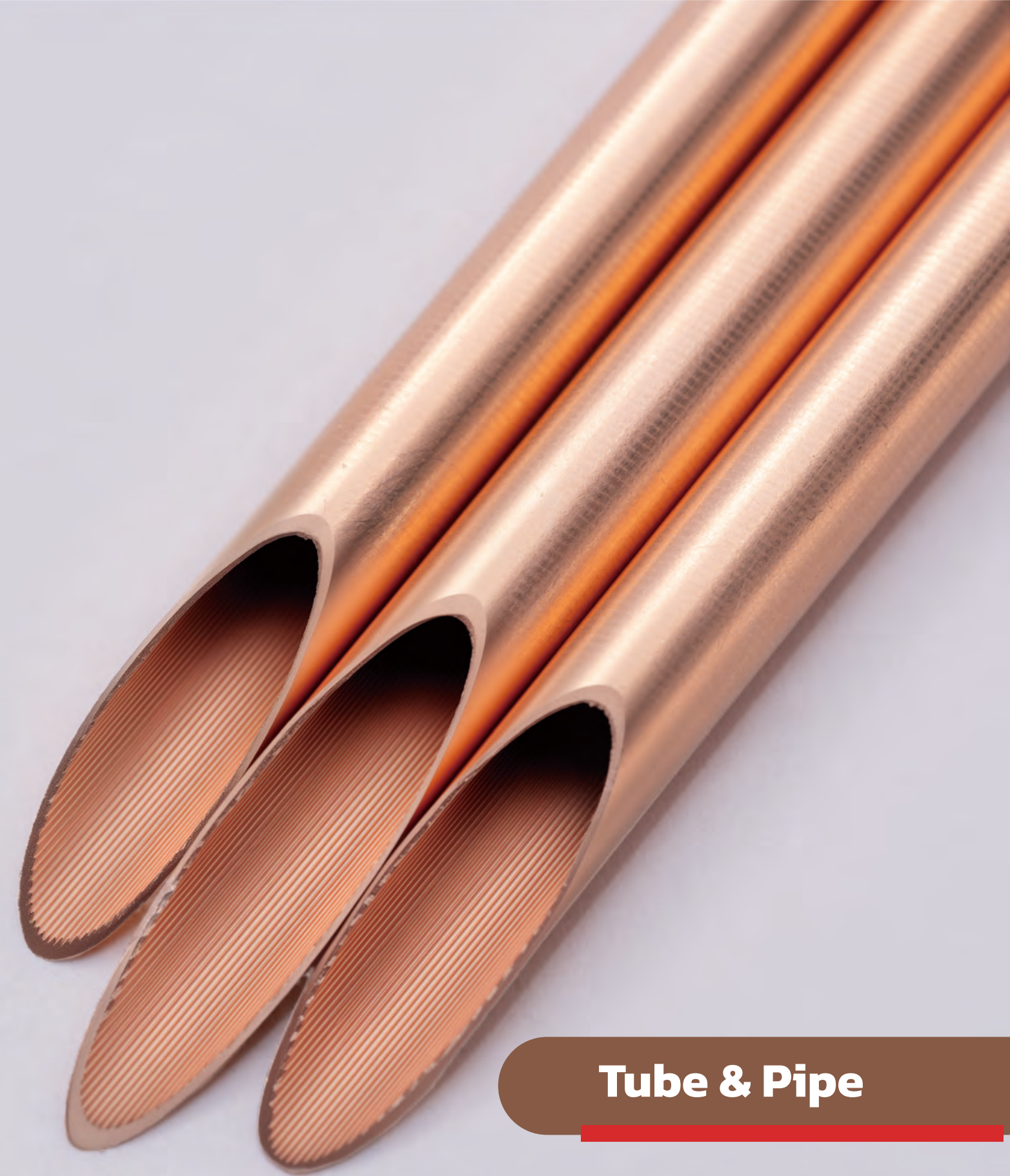

# Tube & Pipe

- Smooth & IGT (LWC/Jumbo)
- Alloy Tube
- Plumbing | Refrigeration Coil & ACR Length | Line sets
- Aluminum Tube
- Fin Tube

■ COPPER TUBE-SMOOTH & IGT (LWC/JUMBO)

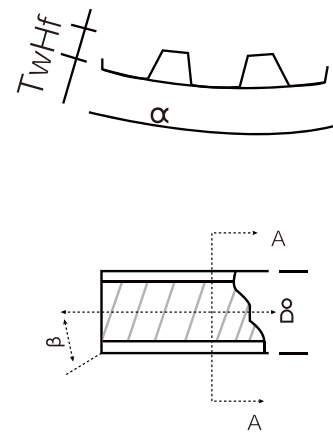

Product Type	Size Range
Jumbo Coil	1/4' ~ 1/2'
LWC (Smooth)	3/16' ~ 7/8'
LWC (IGT)	3/16 ~ 1/2'

PLUMBING | REFRIGERATION COIL & ACR LENGTH | LINE SETS ■



ASTM B88 APPROVED

IAPMO Certification UPC and NSF61 for copper pipe of sanitary and heating installations

COPPER TUBE PLUMBING		TYPE K			TYPE L			TYPE M	DWV	MEDICAL GAS	
Nominal or Standard Size, in	Outside Diameter, in	Hard Lengths	Soft Coils	Soft Lengths	Hard Lengths	Soft Coils	Soft Lengths	Hard Lengths	Hard Lengths	Mitrogenized thru 3-1/8" only	
										Type K Hard Lengths	Type L Hard Lengths
1/4"	3/8"	2 ft ~ 20 ft	40 ft ~ 100 ft	2 ft ~ 20 ft	2 ft ~ 20 ft	40 ft ~ 100 ft	2 ft ~ 20 ft	-	-	10 ft., 20 ft	10 ft., 20 ft
3/8"	1/2"	2 ft ~ 20 ft	40 ft ~ 100 ft	2 ft ~ 20 ft	2 ft ~ 20 ft	40 ft ~ 100 ft	2 ft ~ 20 ft	2 ft ~ 20 ft	-	10 ft., 20 ft	10 ft., 20 ft
1/2"	5/8"	2 ft ~ 20 ft	40 ft ~ 100 ft	2 ft ~ 20 ft	2 ft ~ 20 ft	40 ft ~ 100 ft	2 ft ~ 20 ft	2 ft ~ 20 ft	-	10 ft., 20 ft	10 ft., 20 ft
5/8"	3/4"	2 ft ~ 20 ft	40 ft ~ 100 ft	2 ft ~ 20 ft	2 ft ~ 20 ft	40 ft ~ 100 ft	2 ft ~ 20 ft	2 ft ~ 20 ft	-	10 ft., 20 ft	10 ft., 20 ft
3/4"	7/8"	2 ft ~ 20 ft	40 ft ~ 100 ft	2 ft ~ 20 ft	2 ft ~ 20 ft	40 ft ~ 100 ft	2 ft ~ 20 ft	2 ft ~ 20 ft	-	10 ft., 20 ft	10 ft., 20 ft
1"	1-1/8"	2 ft ~ 20 ft	40 ft ~ 100 ft	2 ft ~ 20 ft	2 ft ~ 20 ft	40 ft ~ 100 ft	2 ft ~ 20 ft	2 ft ~ 20 ft	-	10 ft., 20 ft	10 ft., 20 ft
1-1/4"	1-3/8"	2 ft ~ 20 ft	40 ft ~ 100 ft	2 ft ~ 20 ft	2 ft ~ 20 ft	40 ft ~ 100 ft	2 ft ~ 20 ft	2 ft ~ 20 ft	2 ft ~ 20 ft	10 ft., 20 ft	10 ft., 20 ft
1-1/2"	1-5/8"	2 ft ~ 20 ft	40 ft ~ 100 ft	2 ft ~ 20 ft	2 ft ~ 20 ft	40 ft ~ 100 ft	2 ft ~ 20 ft	2 ft ~ 20 ft	2 ft ~ 20 ft	10 ft., 20 ft	10 ft., 20 ft
2"	2-1/8"	2 ft ~ 20 ft	40 ft ~ 100 ft	2 ft ~ 20 ft	2 ft ~ 20 ft	40 ft ~ 100 ft	2 ft ~ 20 ft	2 ft ~ 20 ft	2 ft ~ 20 ft	10 ft., 20 ft	10 ft., 20 ft
2-1/2"	2-5/8"	2 ft ~ 20 ft	-	2 ft ~ 20 ft	2 ft ~ 20 ft	-	2 ft ~ 20 ft	2 ft ~ 20 ft	-	10 ft., 20 ft	10 ft., 20 ft
3"	3-1/8"	2 ft ~ 20 ft	-	2 ft ~ 20 ft	2 ft ~ 20 ft	-	2 ft ~ 20 ft	2 ft ~ 20 ft	2 ft ~ 20 ft	10 ft., 20 ft	10 ft., 20 ft
3-1/2"	3-5/8"	2 ft ~ 20 ft	-	-	2 ft ~ 20 ft	-	-	2 ft ~ 20 ft	-	10 ft., 20 ft	10 ft., 20 ft
4"	4-1/8"	2 ft ~ 20 ft	-	-	2 ft ~ 20 ft	-	-	2 ft ~ 20 ft	2 ft ~ 20 ft	10 ft., 20 ft	10 ft., 20 ft
5"	5-1/8"	2 ft ~ 20 ft	-	-	2 ft ~ 20 ft	-	-	2 ft ~ 20 ft	2 ft ~ 20 ft	10 ft., 20 ft	10 ft., 20 ft
6"	6-1/8"	2 ft ~ 20 ft	-	-	2 ft ~ 20 ft	-	-	2 ft ~ 20 ft	-	10 ft., 20 ft	10 ft., 20 ft
8"	8-1/8"	2 ft ~ 20 ft	-	-	2 ft ~ 20 ft	-	-	2 ft ~ 20 ft	-	10 ft., 20 ft	10 ft., 20 ft

■ PLUMBING | REFRIGERATION COIL & ACR LENGTH | LINE SETS



**EZ-PULL Line Sets**

- Available in white or black exterior hardshell
- Meets ASTM E84 for smoke and fire (25/50)
- Superior tear resistance
- Rugged, anti-tear exterior allows for easier installation of the line set
- UV Resistant
- R-410A, R-32 & R-454B Approved
- Insulation is marked every foot
- 1/2" Wall R3.3 Minimum\*
- 3/4" Wall R5.2 Minimum\*
- Can be ordered with Flare Nuts or Plain Ends.

**Tube Size Lengths**

1/4" - 5/8" 25', 50', 100' and 164' coils  
 3/4 - 7/8" 50' coils

**Insulation Wall Thickness**

1/2" & 3/4"

**Rubber Line Sets**

- Meets ASTM E84 for smoke and fire (25/50)
- UV Resistant
- R-410A, R-32 & R-454B Approved

**Tube Sizes Lengths**

1/4" - 7/8" 10' - 100'  
 1 1/8" 10' - 50'

**Insulation Wall Thickness**

3/8", 1/2" 3/4" & 1"

■ COPPER FIN TUBE

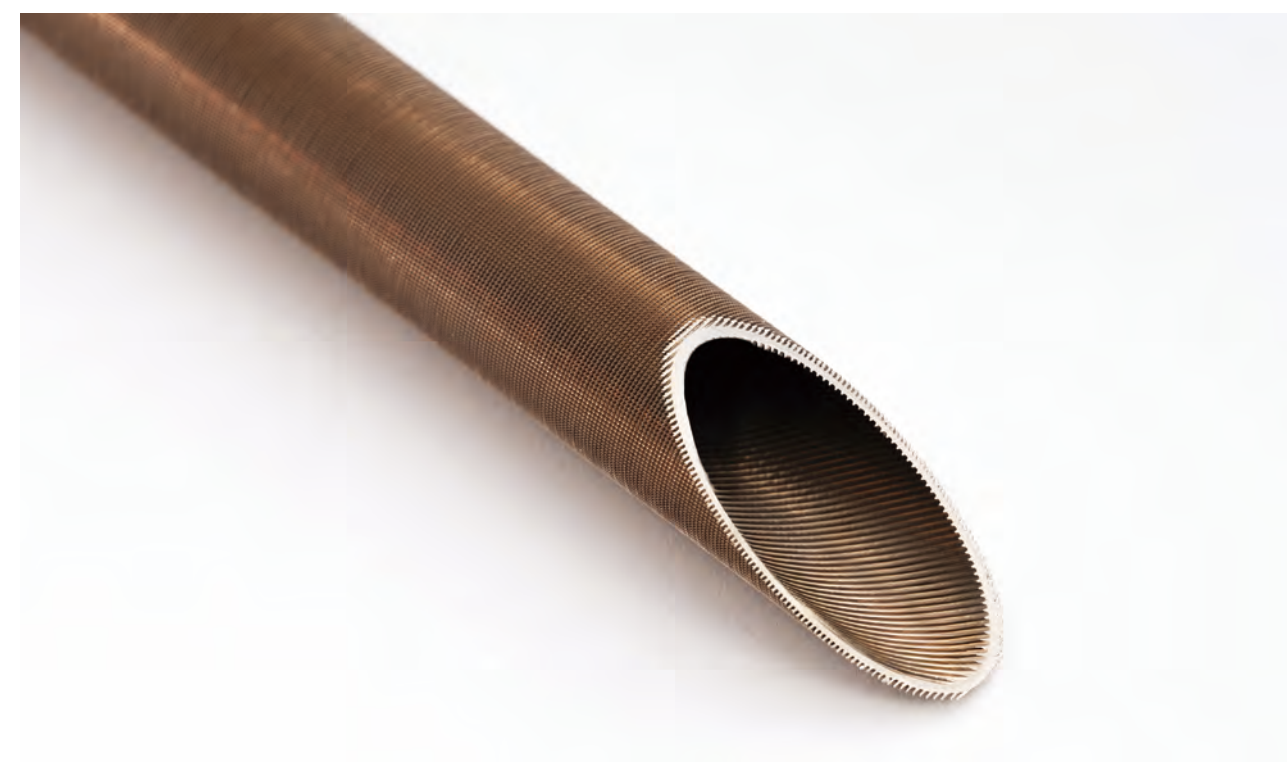

PRODUCT TYPE	Size Range
Fin Tube	1/2" - 1 1/2"

■ COPPER ALLOY TUBE



**Main Products**

- Admiralty Brass Tube C44300
- Al-Brass Tube C68700
- CuNi Tube C70600
- CuNi Tube C71500/C71640

**SPECIFICATION SCOPE OF HIGH ACCURACY COPPER ALLOY TUBE**

Size Range	Thickness (unit:inch)											Length (FT)
	0.0157	0.0157 to 0.0394	0.0394 to 0.0787	0.0787 to 0.1181	0.1181 to 0.1575	0.1575 to 0.1969	0.1969 to 0.2362	0.2362 to 0.2756	0.2756 to 0.3150	0.3150 to 0.3937	0.3937 to 0.4724	
3/16 to 3/8	○	○										≤ 82
3/8 to 13/16	○	○	○	○	○							≤ 82
13/16 to 1-15/16		○	○	○	○	○	○	○				≤ 82
1-15/16 to 3-15/16			○	○	○	○	○	○	○	○	○	≤ 49
3-15/16 to 7-7/8				○	○	○	○	○	○	○	○	≤ 39
7-7/8 to 11-13/16					○	○	○	○	○	○	○	≤ 20
11-13/16 to 16-1/2					○	○	○	○	○	○	○	≤ 20

■ ALUMINUM TUBE

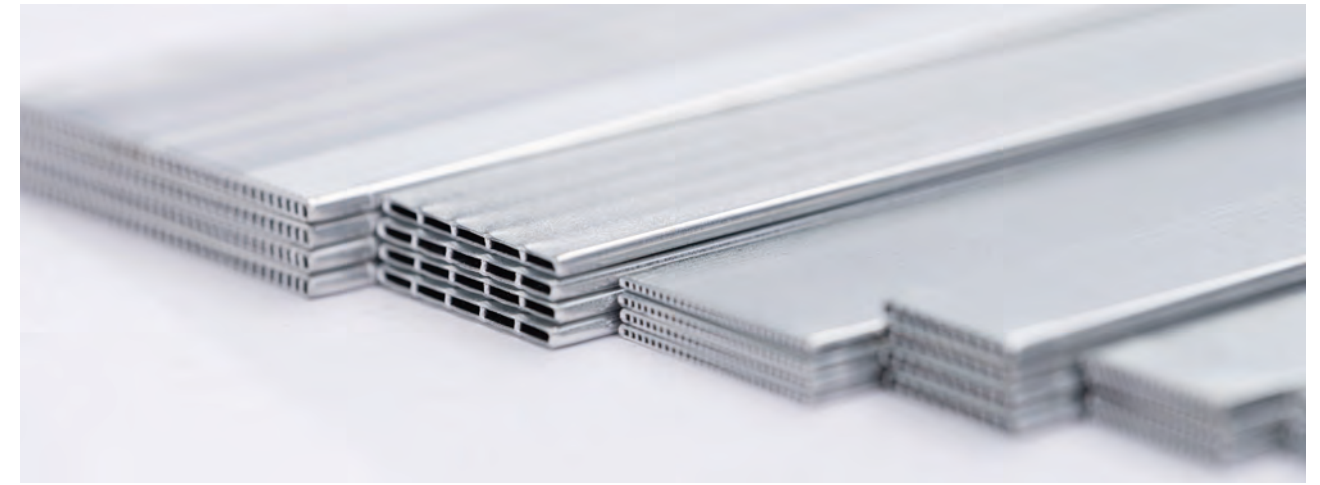

**Main Applications**

Aluminum Multi-Port Extrusion Tubes are mainly used in Microchannel Heat Exchangers (MCHE), which offer higher heat transfer efficiency.

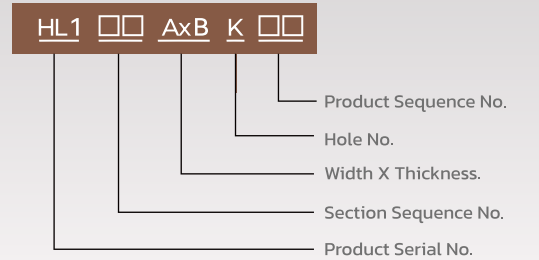
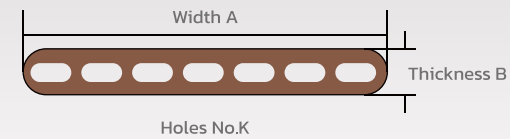

MODEL	WIDTH(INCH)	THICKNESS(ICH)	HOLES NUMBER	LBS/FT	MATERIAL GRADE
HL1-1-12x1.4-12-1	1/2	0.055	12	0.0180	3102
HL1-2-16x1.3-16-1	5/8	0.051	16	0.0245	3102
HL1-4-16x2-10-1	5/8	0.079	10	0.029	1100
HL1-15-20x1.8-10-1	13/16	0.071	10	0.0364	3102
HL1-35-20x1.8-12-1	13/16	0.071	12	0.0324	1100
HL1-21-25x2-18-1	1	0.079	18	0.0507	3102
HL1-6-25.4x2-13-1	1	0.079	13	0.0472	3102
HL1-8-26x2-21-1	1	0.079	21	0.0501	3102
HL1-91-26x2-13-1	1	0.079	13	0.0523	1100
HL1-22-32x2-25-3	1-1/4	0.079	25	0.0642	3102
HL1-39-32x2.05-6-1	1-1/4	0.081	6	0.060	3003
HL2-15-45x2.5-8	1-3/4	0.098	8	0.0577	3F03
HL2-28-50x5-10	1-15/16	0.197	10	0.1281	3F03
HL2-26-57x5-10	1-1/4	0.197	10	0.1791	3F03



## Copper & Brass Fitting

- Wrot Copper Fitting
- Press Connection
- K65 Copper Iron
- F1807 Crimp Pex
- F1960 Cold Expansion
- DWV Wrot Copper
- Flare Fitting
- Brass Compression Fitting

### WROT COPPER FITTING



#### Description

Wrot copper fittings are manufactured from a high-quality copper alloy that is known for its durability and resistance to corrosion. They are designed for connecting copper pipes in plumbing applications, ensuring tight seals and reliable performance.

#### Standards

ASME B16.22 – Standard for Wrought Copper and Copper Alloy Solder Joint Pressure Fittings  
**ANSI/ASME B16.18:** Standard for Cast Copper Alloy Solder Joint Pressure Fittings

#### Functions

Used for soldered joints in water systems, HVAC installations, and refrigeration lines.

#### Certifications

UPC certified, Lead-free applied, compliant with NSF/ANSI 61 for drinking water system components

#### Materials

C12200 copper (99.9% copper content), C46500, C69300

PARTS FAMILIES	NOMINAL SIZE RANGE(OD SIZE ADD 1/8)
Copper Male Adapter CXM	1/8-4inch
Copper Female Adapter CXF	1/8-4inch
Fitting Reducer Male Adapter FtgXM	3/8-2inch
Fitting Reducer Female Adapter FtgXF	3/8-2inch
Flush Bushing FtgXC	1/4-2inch
Cap	1/8-6inch
Coupling w/Rolled Stop CXC	1/8-8inch
Coupling w/Dimple Stop CXC	1/8-8inch
Coupling with No Stop CXC	1/8-8inch
Reducing Coupling CXC	1/8-6inch
90° Short Turn Ell CXC	1/8-8inch
90° Long Turn Ell CXC	1/8-4inch
90° Short Turn Street Ell FtgXC	1/8-4inch
90° Long Turn Street Ell FtgXC	1/8-4inch
45° Ell CXC	1/8-8inch
45° Street Ell FtgXC	1/8-4inch
Fitting Reducer FtgXC	1/8-4inch
Tee CXCXC	1/8-6inch
Suction Line P-Trap CXC	1/2-2inch
Union No Lead CXC	1/4-4inch
U-Type Strap	1/8-2inch
Crossover CxC	1/2-2inch
Half-Crossover CxC	1/2-2inch
Brass Male Adapter CXM	1/2-2inch
Brass Female Adapter CXF	1/2-2inch
Brass Female Thread Elbow CXF	1/2-2inch
Brass Male Thread Elbow CXM	1/2-2inch
Brass Female Thread Drop-Ear Elbow CXF	1/2-2inch
Brass Female Thread Tee CXF	1/2-2inch

## PRESS CONNECTION ■



### Description

Press connections are designed to provide secure and durable joints in piping systems without the need for soldering or welding. Utilizing a specialized crimping tool, these fittings create a tight seal that enhances the reliability of plumbing installations.

### Functions

Ideal for water distribution systems, HVAC applications, and where quick and reliable connections are necessary without flames. The press technology allows for efficient installations while reducing labor costs and safety risks associated with traditional soldering techniques.

### Certifications

UPC certified, Lead-free applied, compliant with NSF/ANSI 61 for drinking water system components

### Standards

**ASME B16.51:** This standard specifies the requirements for metallic fittings employed in piping systems using the press-connect method, ensuring structural integrity and consistent quality.

**ANSI/ASME B16.18:** Standard for Cast Copper Alloy Solder Joint Pressure Fittings, often used in conjunction with press fittings.

**ASTM F1807** – Standard Specification for Crimp PEX Fittings for Use with PEX tubing, used in conjunction with press to Pex connection.

**ASTM F1960** – Standard Specification for Cold Expansion Fittings with PEX Tubing, used in conjunction with press to CE connection.

### Materials

C12200, C46500, C69300, EPDM O-ring, HNBR O-ring, FKM O-ring

PARTS FAMILIES	NOMINAL SIZE RANGE
Copper Press Couplings w/Stop - PXP Rolled	1/2-4inch
Copper Press Couplings Less/Stop - PXP	1/2-4inch
Copper Press Couplings w/Stop - PXP Dimple	1/2-4inch
Copper Press Extended Couplings - PXP No Stop	1/2-2inch
Copper Press 90 Deg. Elbows PXP	1/2-4inch
Copper Press 90 Deg. Street Elbows Ftg.XP	1/2-4inch
Copper Press x FPT 90 Deg. Elbows PXF	1/2-2inch
Copper Press Flange	1/2-4inch
Copper Press 45 Deg. Elbows PXP	1/2-4inch
Copper Press 45 Deg. Street Elbows FtgXP	1/2-4inch
Copper Press Tees PXPXP	1/2-4inch
Copper Press Tube End Cap	1/2-4inch
Copper Press Reducer Couplings w/Stop - PXP	1/2-4inch
Copper Press Fitting Reducer Ftg.XP	1/2-4inch
Copper Press Female Adapters PXF	1/2-4inch
Copper Press Male Adapters P X M	1/2-4inch
Copper Press Female Tee P X F	1/2-4inch
Copper Press Adapter Reducer Ftg X FIP	1/2-2inch
Copper Press Adapter Reducer Ftg X MIP	1/2-2inch
Brass Press Union PxFTPT	1/2-2inch
Brass Press Union PxMPT	1/2-2inch
Brass Press Union P x P	1/2-2inch
90° Drop Ear Elbow No Lead brass P x FPT	1/2-2inch
Brass Press x Male MPT Elbow	1/2-2inch
Brass Press x Female FPT Elbow	1/2-2inch
Brass Press x Female Adapters PXF	1/2-2inch
Brass Press Male Adapters P X M	1/2-2inch
Press x Crimp(F1807), PEX-B Adapter	1/2-1 1/2inch
Press x Expansion(F1960), PEX-A, PEX Adapter	1/2-1 1/2inch
Press x Expansion(F1960), PEX-A, PEX Adapter	1/2-1 1/2inch
Press x Crimp(F1807), PEX-B, Elbow	1/2-1 1/2inch
Press x Press x Pex (Crimp, F1807, PEX-B) Tee	1/2-1 1/2inch
Press x Press x Pex (expansion), PEX-A, Tee	1/2-1 1/2inch
Brass Press Flange	1/2-4inch

## ■ K65 COPPER IRON



### Description

K65 copper iron fittings are designed for high-performance applications, particularly within commercial refrigeration systems using CO2 (R-744) as a refrigerant. These fittings present an environmentally friendly option with zero ozone depletion potential (ODP) and a low global warming potential (GWP) of 1.

### Features and Benefits

**Operating Pressure:** K65 fittings are UL 207 recognized, with a maximum operating pressure of 130 bar.

**Identification:** They are easily distinguishable from traditional copper fittings due to their slight magnetic properties and markings indicating "K65" and "130 bar."

**Warranty:** Professionally installed K65 fittings come with a 25-year warranty.

**Compatibility:** K65 fittings can be welded to K65 pipes without the need for expensive specialized TIG welding equipment.

**Corrosion Resistance:** K65 exhibits immunity to stress corrosion cracking and shows excellent corrosion resistance in both natural and industrial environments.

### Functions

K65 fittings are ideal for high-pressure and high-temperature systems, providing reliable connections under demanding conditions. They can withstand operational pressures up to 130 bar, making them suitable for supermarket refrigeration systems and other commercial applications.

### Standards and Certifications

**Standards:** K65 meets various international standards, including: UL 207 for pressure components  
VdTUV Material Handbook 567 for seamless drawn CuFe2P (CW107C) pipes

**Certifications:** Compliant with ISO 9001 for quality management systems and UL 207 for pressure components

**Materials:** EN CuFe2P CW107C and UNS C19400 alloys.

PARTS FAMILIES	OD SIZE RANGE
K65 90° Street Elbow FtgxC	3/8OD-2 5/8OD inch
K65 90° Elbow CxC	3/8OD-2 5/8OD inch
K65 45° Street Elbow FtgxC	3/8OD-2 5/8OD inch
K65 45° Elbow CxC	3/8OD-2 5/8OD inch
K65 Tee CxCxC	3/8OD-2 5/8OD inch
K65 Tee Reducing CxCxC	3/8OD-2 5/8OD inch
K65 Reducing Coupling CxC	3/8OD-2 5/8OD inch
K65 Fitting Reducer FtgxC	3/8OD-2 5/8OD inch
K65 End Cap	3/8OD-2 5/8OD inch

## F1807 CRIMP PEX



### Description

F1807 PEX fittings are specifically designed to connect cross-linked polyethylene (PEX) pipes, providing a robust and flexible solution for modern plumbing systems.

### Standards

**ASTM F1807** – Standard Specification for Copper and Copper Alloy Fittings for Use with PEX tubing

### Materials

C46500 BRASS, C69300 BRASS known for its high ductility and corrosion resistance

### Functions

Excellent for both hot and cold water applications, offering superior flexibility and resistance to scale and chlorine.

### Certifications

UPC certified. Lead free applied. Meets NSF/ANSI 61 and NSF/ANSI 14 standards, ensuring safety and quality for potable water systems.

PARTS FAMILIES	NOMINAL SIZE RANGE
Male Adapter Crimp PEX X MIP F1807 (A) NL BRASS	3/8-1 1/2inch
Female Adpt Crimp PEX X FPT F1807 (A) NL BRASS	3/8-1 1/2inch
Female Elbow Crimp PEX X FPT F1807 (A) NL BRASS	3/8-2inch
MALE ELBOW Crimp PEX X MPT F1807 (A) NL BRASS	3/8-2inch
COUPLING Crimp PEX X PEX F1807 (A) NL BRASS	3/8-2inch
PEX Elbow Crimp PEX X PEX F1807 (A) NL BRASS	3/8-2inch
PEX Drop Ear Elbow PEX X FIP F1807 (A) NL BRASS	1/2-1inch
PEX X PB Transition Coupling F1807 (A) NL BRASS	3/8-1inch
PEX x Female Sweat Elbow F1807 (A) NL BRASS	3/8-1 1/2inch
PEX x Female Sweat Adapter F1807 (A) NL BRASS	3/8-1 1/2inch
F1807 BRASS PEX Plug (No Lead)	3/8-1 1/2inch
PEX x Male Sweat Elbow F1807 (A) NL BRASS	3/8-1 1/2inch
PEX x Male Sweat Adapter F1807 (A) NL BRASS	3/8-1 1/2inch
PEX Tee F1807 PEX x PEX x PEX NL BRASS	3/8-1 1/2inch
F1807 PEX x FPT Swivel Adpt (plastic nut) NL BRASS	3/8-1inch
F1807 PEX x FPT Swivel Elbow (plastic nut) NL BRASS	3/8-1inch
F1807 PEX x FPT Swivel Elbow (Brass nut) NL BRASS	3/8-1inch
F1807 PEX x FPT Swivel Adapter (Brass nut) NL BRASS	3/8-1inch
PEX Crimp Ring, Black Copper	3/8-2inch
PEX Crimp Ring, Copper Color	3/8-2inch
F1807 PEX STUB OUT ELBOW	1/2-3/4inch
F1807 PEX STUB OUT ELBOW W/ WALL FLANGE	1/2-3/4inch
F1807 PEX STRAIGHT STUB OUT	1/2-3/4inch

## F1960 COLD EXPANSION



### Description

F1960 PEX-A fittings utilize a unique cold expansion technology that allows for easy installation without the need for soldering or crimping. This makes them a preferred choice for contractors looking for efficiency.

### Standards

**ASTM F1960** – Standard Specification for Cold Expansion Fittings with PEX-A Tubing

### Materials

Made from high-quality C46500 LF BRASS or C69300 BRASS, ensuring excellent mechanical performance and longevity

### Functions

Suitable for residential plumbing systems including hot and cold water lines that require a strong and durable connection.

### Certifications

UPC Certified. Lead free applied. Meets NSF/ANSI 61, ensuring suitability for drinking water applications

PARTS FAMILIES	NOMINAL SIZE RANGE
F1960 BRASS CE PEX MALE ADAPTER LF F1960 X MIP	3/8-2inch
F1960 BRASS CE PEX FEMALE ADAPTER LF F1960 X FIP	3/8-2inch
F1960 x MALE SWEAT CE PEX BRASS ADAPTER LF	3/8-2inch
F1960 x FEMALE SWEAT CE PEX BRASS ADAPTER LF	3/8-2inch
F1960 BRASS CE PEX COUPLING LF	3/8-2inch
F1960 BRASS CE PEX DROP EAR ELBOW LF F1960 X FIP	1/2-1inch
F1960 BRASS CE PEX ELBOW LF	3/8-2inch
F1960 BRASS CE PEX TEE LF	3/8-2inch
F1960 BRASS CE PEX PLUG LF	3/8-2inch
F1960 BRASS PEX X PLASTIC SWIVEL ELBOW LF F1960 X FIP	3/8-1inch
F1960 BRASS CE PEX MALE SWEAT ELBOW LF	3/8-2inch
F1960 BRASS CE PEX FEMALE SWEAT ELBOW LF	3/8-2inch
F1960 PEX STUB OUT ELBOW	3/8-3/4inch
F1960 PEX STUB OUT ELBOW W/ WALL FLANGE	3/8-3/4inch
F1960 PEX STRAIGHT STUB OUT	3/8-3/4inch

## DWV WROT COPPER



### Description

DWV WROT (Wrought) Copper fittings are designed for drain, waste, and vent (DWV) systems. Using solder joints, they provide reliable connections and easy installation.

### Standards

Manufactured per ASME B16.29, which specifies the requirements for wrought copper solder joint drainage fittings, ensuring quality and performance.

### Functions

These fittings are ideal for residential and commercial plumbing, ensuring strong, leak-resistant connections for waste and vent lines.

### Materials

Made from high-quality wrought copper, ensuring durability and excellent mechanical performance, with a content of at least 84% copper for corrosion resistance.

PARTS FAMILIES	NOMINAL SIZE RANGE
DWV Copper Male Adapter CXM	1-2 1/2inch
DWV Copper Female Adapter CXF	1-2 1/2inch
DWV Test Cap	1-2 1/2inch
DWV Coupling w/Dimple Stop CXC	1-2 1/2inch
DWV Coupling with No Stop CXC	1-2 1/2inch
DWV Reducing Coupling CXC	1-2 1/2inch
DWV 90° Elbow CXC	1-2 1/2inch
DWV 90° Street Elbow FtgXC	1-2 1/2inch
DWV 45° Elbow CXC	1-2 1/2inch
DWV 45° Street Elbow FtgXC	1-2 1/2inch
DWV Fitting Reducer FtgXC	1-2 1/2inch
DWV Tee CXCXC	1-2 1/2inch

## FLARE FITTING



### Description

Flare fittings are designed for secure connections in metal tubing, ideal for high-pressure applications. They effectively resist mechanical pull-out, ensuring robust, leak-resistant joints.

### Standards

**ISO 8434-2** – Metallic Tube Connections for Fluid Power and General Use

**SAE L512 & SAE J513** – Compatibility standards for specific applications.

### Materials

Typically made from brass (C37700), flare fittings provide excellent machinability and corrosion resistance, ensuring long-lasting reliability.

### Functions

These fittings are commonly used in fuel gas delivery systems and refrigeration lines. They are preferred for higher pressures compared to compression fittings. Flare fittings are compatible with materials like aluminum, copper, brass, and welded steel tubing, making them suitable for various applications, including fuel, oil, liquefied petroleum (LP), and natural gas lines.

### Operating Specifications

**Temperature Range:** Operates between -65° F to 250° F, depending on application.

**Working Pressure:** Varies based on tube size and material; refer to specific specifications for maximum pressures.

PARTS FAMILIES	OD SIZE RANGE
LONG FLARE NUT FORGED	1/4-3/4inch
SHORT FLARE NUT FORGED	1/4-3/4inch
90° ELBOW Flare x Flare	1/4-3/4inch
90° ELBOW Flare x FIP	1/4-3/4inch
90° ELBOW Flare x MIP	1/4-3/4inch
FLARE UNION Flare x Flare	1/4-3/4inch
FLARE CONNECTOR FLARE x MIP	1/4-3/4inch
FLARE CONNECTOR FLARE x FIP	1/4-3/4inch
FLARE CONNECTOR MALE FLARE x FEMALE FLARE	1/4-3/4inch
Flare Swivel FEMALE FLARE x FEMALE FLARE	3/8-1/2inch
Flare CAP	1/4-3/4inch
Flare PLUG	1/4-3/4inch
FLARE TEE	1/4-3/4inch

**BRASS COMPRESSION FITTING**



**Description**

Brass compression fittings are mechanical couplings used extensively for securely connecting various types of tubes. These fittings are especially noted for their durability, strength, and resistance to corrosion, widely used in plumbing, hydraulic, and pneumatic systems, as well as automotive applications where secure connections are necessary.

**Standards**

**NSF 372 Certified:** Safe for drinking water with low-lead content. Conforming to ANSI B1.20.1 and SAE J512 standards.

**Functionality**

Brass compression fittings create leak-proof connections for transporting liquids and gases in plumbing and various systems. They can handle pressure ratings up to 150 psi at temperatures of around 73°F (23°C) and are easy to install without soldering, welding, or special tools, making them convenient for both professionals and DIY users.

**Materials**

Generally made from brass C69300, C46500 and C37700

PARTS FAMILIES	OD SIZE RANGE
COMPRESSION SLEEVE RING	1/8OD-3/4ODinch
COMPRESSION NUT	1/8OD-3/4ODinch
COMPRESSION UNION COMP x COMP	1/8OD-3/4ODinch
COMPRESSION TEE	1/8OD-3/4ODinch
COMPRESSION MALE ADAPTER COMP x MIP	1/8OD-3/4ODinch
COMPRESSION FEMALE ADAPTER COMP x FIP	1/8OD-3/4ODinch
COMPRESSION ELBOW COMP x COMP	3/16OD-3/4ODinch
COMPRESSION MALE ELBOW COMP x MIP	1/8OD-1/2ODinch
COMPRESSION FEMALE ELBOW COMP x FIP	1/8OD-1/2ODinch



# MALLEABLE IRON PIPE FITTING



90# elbow  
round edged



90# elbow  
square edged



92#



270# coupling



130# tee  
round edged



130# tee  
square edged



241# bushing



291# plug



180#  
square edged



45# elbow



301# round cap



340# union, conical  
joint, brass to iron seat



180#  
no edged



240#  
reduce Bushing



pipe nipple



KC nipple

**CLASSIFY**  
**BY WEIGHT:** LIGHT/HEAVY  
**BY STYLE:** NO RIBBED / RIBBED  
**BY EDGED:**  
 ROUND EDGED / SQUARE EDGED / NO EDGED  
**BY SURFACE TREATMENT:**  
 SELF-COLOR BLACK / GALV. / ROAST PLATING / HOT DIP

**AMERICAN STANDARD**  
 300 PSI MALLEABLE IRON PIPEFITTING  
 150 PSI MALLEABLE IRON PIPEFITTING  
 MATERIAL: ASTM A-197 ASTM A47  
 DIMENSIONS: ASME B16.3, B16.4  
 UNION DIMENSIONS: B16, 39  
 THREADS: ANSI B1. 20. 1(NPT)  
 SIZE AVAILABLE: 1/8"-6"

**BRITISH STANDARD**  
 MATERIAL: ASTM A-197 ASTM A47  
 DIMENSIONS: BS EN 10242, BS 143&1256  
 THREADS: ISO7/1  
 SIZE AVAILABLE: 1/8"-6"



**Long Radius Pipe Elbow**

Seamless elbow:  
1/2"-24", DN15-DN600 OD21MM-610MM  
 Welded Elbow:  
4" ~78", DN100-DN1900 OD114MM-1980MM

**Short Radius Pipe Elbow**  
 Seamless elbow:1/2"-24"DN15"DN600  
 Welding elbow:6"-60"DN150"DN1500



**Pipe Tee**

seamless size: 1/2"-24"DN15"DN600  
 welding size: 4"-78" DN150"DN1900



**Pipe Bend**

Seamless tube bending:  
1/2"-24" DN15"DN600  
 Welded tube bending:  
6"-60" DN150"DN1500



**Pipe Reduce**

seamless pipe reducer: 1/2"-24"DN15"DN600  
 welding pipe reducers: 4"-78" DN150"DN1900



**Pipe Cap**

size: 1/2"-78" DN15"DN1900



**Pipe Cross**

Seamless Cross:1/2"-24"DN15"DN600  
 Weld Cross: 4"-78" DN150"DN1900

**Standards**  
 ASME B16.9-2007 ASME B16.25-2007 ASME B16.5-2007 EN10253-1-1999 EN10253-2-2007 EN10253-3-2008 EN10253-4-2008  
 DIN2605-1-1992 DIN2605-2-1995  
**wall thickness**  
 sch10, sch20, sch30, std, sch40, sch60, xs, sch80, sch100, sch120, sch140, sch160, xxs, sch5s, sch20s, sch40s, sch80s, max wall thickness: 150mm  
**materials**  
 carbon steel: ASTM/ASME A234 WPB-WPC  
 alloy steel: ASTM/ASME A234 WP 1-WP 12-WP 11-WP 22-WP 5-WP 91-WP 911  
 stainless steel: ASTM/ASME A403 WP 304-304L-304H-304LN-304N ASTM/ASME A403 WP 316-316L-316H-316LN-316N-316Ti  
 ASTM/ASME A403 WP 321-321H ASTM/ASME A403 WP 347-347H  
 low-temperature steel: ASTM/ASME A402 WPL 3-WPL 6 high performance: ASTM/ASME A860 WPHY 42-46-52-60-65-70



**Weld Neck Flange**

3/8"-160"  
 DN10-DN4000

Pressure

American Series: CLASS 150, CLASS 300, CLASS 400, CLASS 600, CLASS 900, CLASS 1500, CLASS 2500  
 European Series: PN 2.5, PN 6, PN 10, PN 16, PN 25, PN 40, PN 63, PN 100, PN 160, PN 250, PN 320, PN 400  
 Flange Facin Types  
 American Series: Flat Face (FF), Raised face (RF), groove (G), femaie(F), ring joints face(RJ)



**Slip On Weld Flange**

3/8"-40"  
 DN10-DN1000

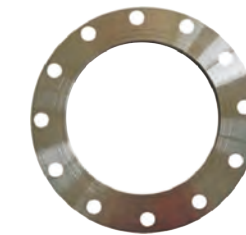

**Plate Weld Flange**

3/8"-100"  
 DN10-DN2500

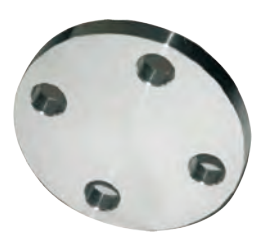

**Blind Flange**

3/8"-100"  
 DN10-DN2500